

New horizon of the
whole world



GLARIE®

ELEVATOR | ESCALATOR

GLARIE®

Add: No.9 Xuqing RD, National New & Hi-tech Industrial Development Zone, New District, Suzhou, Jiangsu, 215151, China.
Tel: +86 0512 6667 7088 Fax: +86 0512 6667 7088 Http:// www.glarie.com
Service Hotline: 400 828 2100 E-mail: info@glarie.com Zip code: 215151

The brochure is only for your reference. Please refer to the respective technical documents, Subject to change without notice.
GLARIE Elevator All Rights Reserved.
GLARIE 2023.5

Germany Classic with Glory of A Century

SMARTLIFTS

Smart Solution Smart Life

88 AP Nakarin Bldg., 20th Floor,
Room no.4, Soi Lasalle 58,
Bangna-Tai, Bangna, Bangkok 10260
Tel : 66-65-098-9909 , Tel: 662-005-7916

With German noble demeanor, we build legendary artistic quality

GLARIE originated in the 19th century is like ancient Swan Stone Castle in Germany. It continues European aristocratic lineage and artistic charm. Swan stone castle was built by Ludwig II of Bavaria personally. It is the exclusive King's dream world, full of art and fairy color. And specifically for the European aristocracy handmade custom GLARIE elevator is perfect into the castle for its noble style, aristocratic art and romantic breathing. All of these create magnificent space and become a popular German classic.

The perfect fusion
Of elevator and art



 Originated From Germany
Inheriting Classics

GLARIE ELEVATOR

In 2013, GLARIE established Suzhou Glarie elevator Co., LTD that as a whole R&D, manufacturing, sales and maintenance in one, located in paradise on earth-Suzhou.

With the best combination of global and local, we will continue German industrial essence to create green, safe, comfortable and intelligent living life for Chinese customers by innovative technology, excellent solution of passenger flow and logistics and international service.

GLARIE in the future will continue to actively participate in the sustainable development construction of urban China. Make contribution to China's urbanization process by the strength of art up.

PASSENGER ELEVATOR

Residential car decoration



Standard

Ceiling	Hairline stainless steel frame, acrylic lighting (CL001)
Side Wall	Hairline stainless steel
Back Wall	Hairline stainless steel
Front Wall	Hairline stainless steel
Floor	PVC



DC218

Ceiling	Baking finish steel plate, LED illumination
Side Wall	Hairline-finished stainless steel, mirror etched stainless steel
Back Wall	Hairline-finished stainless steel, mirror etched stainless steel
Front Wall	Hairline-finished stainless steel
Floor	PVC



DC211

Ceiling	Mirror stainless steel, tube light
Side Wall	Hairline-finished stainless steel, decorative steel plate
Back Wall	Hairline-finished stainless steel, mirror etched stainless steel
Front Wall	Hairline-finished stainless steel
Handrail	Hairline-finished stainless steel, circular tube
Baseboard	Hairline-finished stainless steel
Floor	Marble

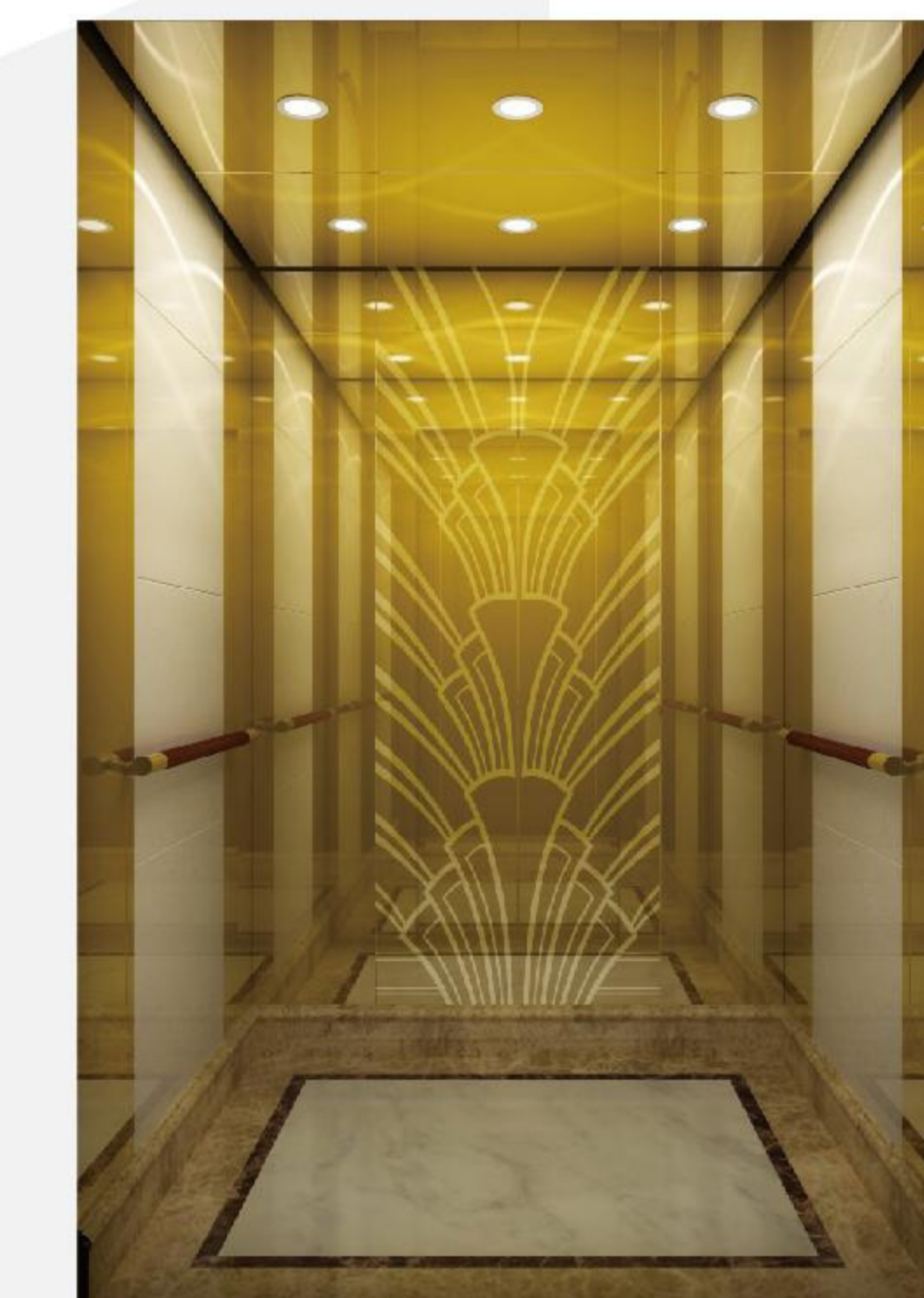

DC226

Ceiling	Titanium mirror stainless steel, downlight
Car Wall	Titanium mirror stainless steel, honeycomb marble, mirror stainless steel etching
Front Wall	Titanium mirror stainless steel
Handrail	Titanium mirror stainless steel round tube
Baseboard	Marble
Floor	Marble



DC221

Ceiling	Bronze mirror stainless steel, acrylic
Car Wall	Bronze mirror etched stainless steel, bronze hairline-finished stainless steel decorative strip, mirror stainless steel
Front Wall	Bronze hairline-finished stainless steel
Handrail	Solid wood, hairline-finished stainless steel tube combination
Baseboard	Bronze hairline-finished stainless steel
Floor	Marble

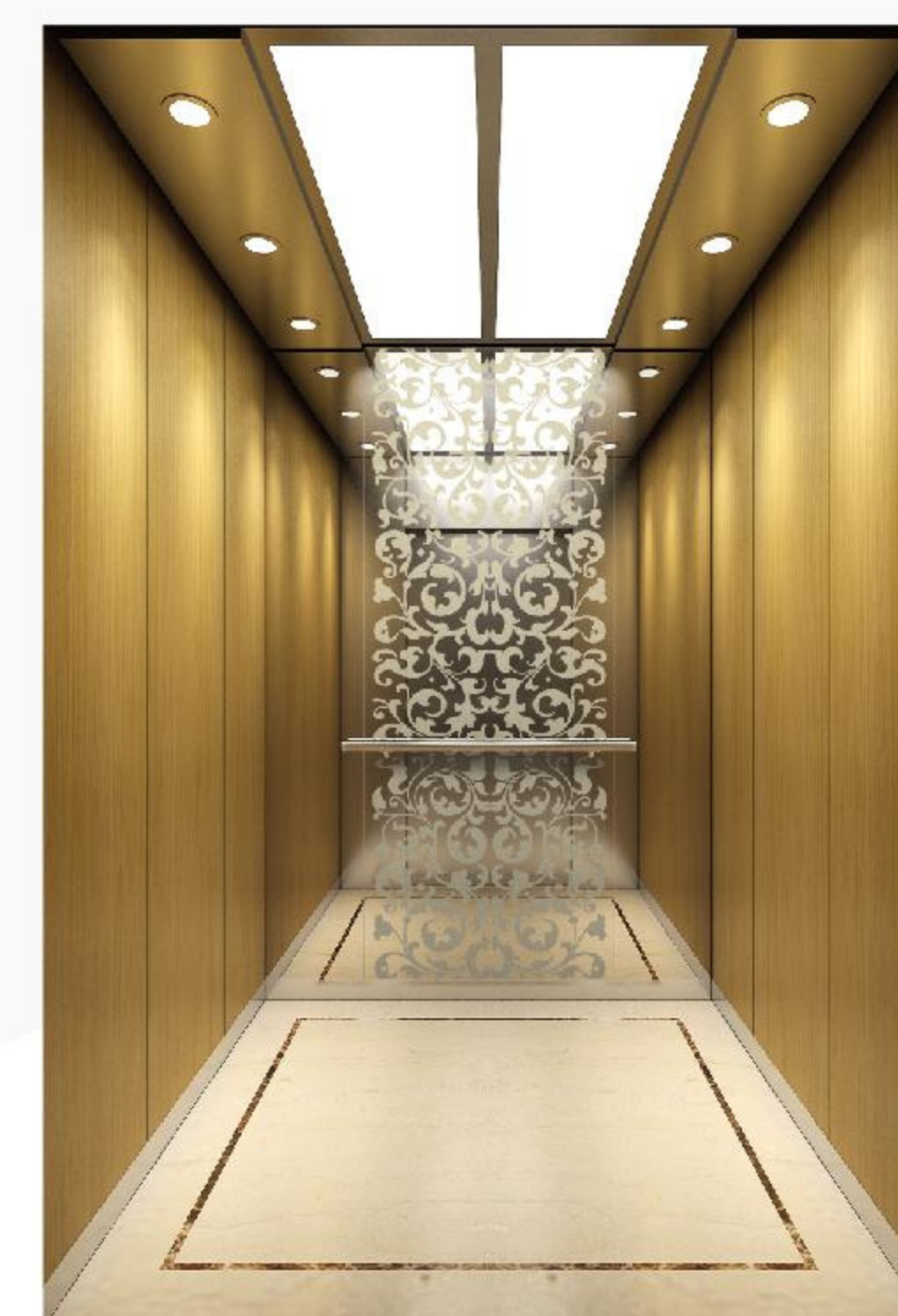

DC222

Ceiling	Hairline-finished stainless steel, down light, acrylic
Car Wall	Mirror stainless steel, mirror etched stainless steel, plasticsteel, hairline-finished stainless steel decorative strip
Front Wall	Hairline-finished stainless steel
Handrail	Hairline-finished stainless steel, circular tube
Baseboard	Hairline-finished stainless steel
Floor	Marble



DC225

Ceiling	Titanium mirror stainless steel, acrylic, downlight
Car Wall	Titanium mirror stainless steel, titanium mirror stainless steel etching
Front Wall	Titanium mirror stainless steel
Handrail	Titanium mirror stainless steel round tube
Baseboard	Titanium mirror stainless steel
Floor	Marble



DC230

Ceiling	Champagne gold sandblasted stainless steel, acrylic, downlight
Side Wall	Champagne gold sanded stainless steel, champagne gold mirror stainless steel
Back Wall	Champagne gold sanded stainless steel, champagne gold mirror stainless steel
Front Wall	Champagne gold sanded stainless steel,
Handrail	Stainless steel round tube
Baseboard	Champagne gold sanded stainless steel,
Floor	Marble

PASSENGER ELEVATOR

Residential car decoration

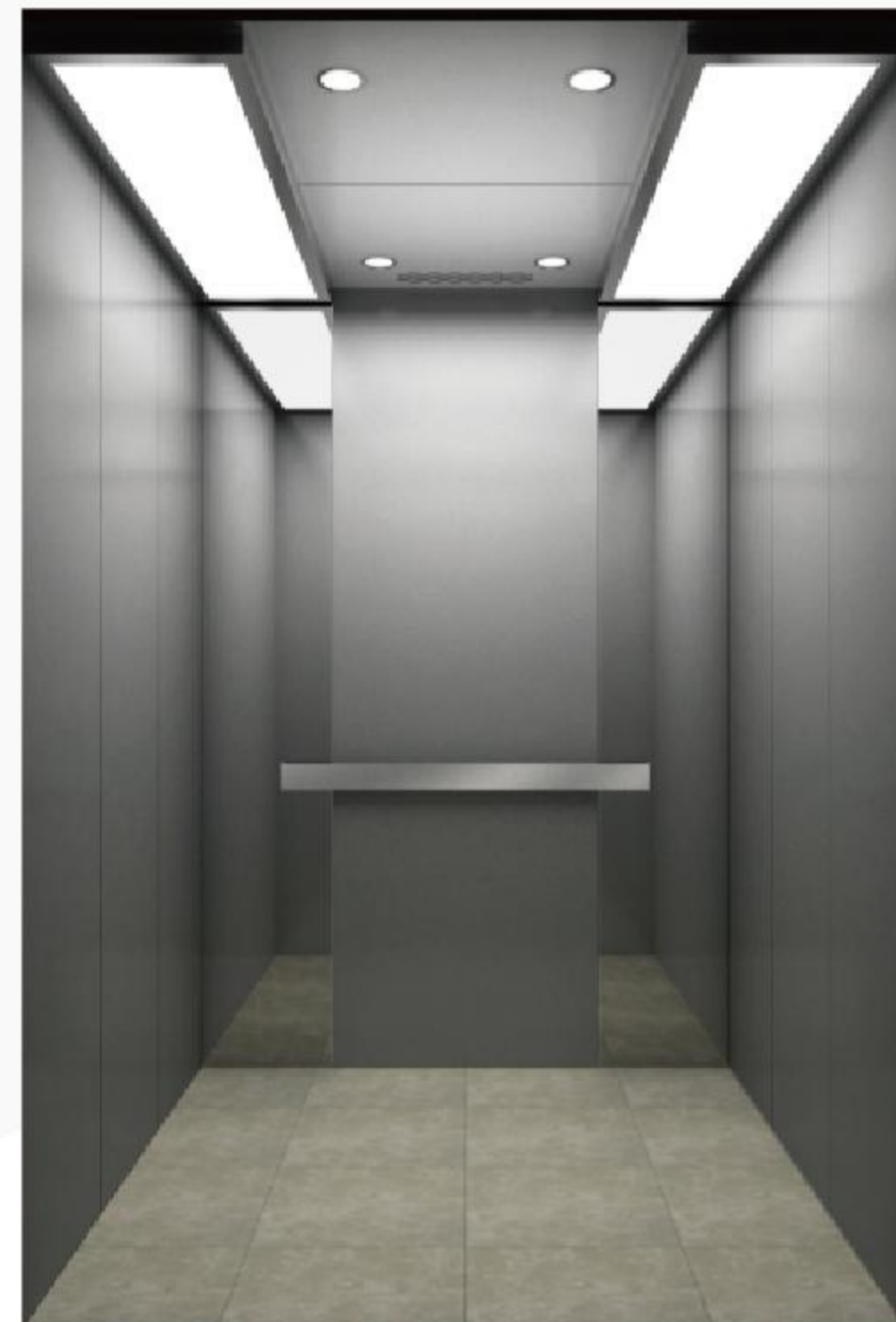

DC228

- Ceiling** Hairline stainless steel, acrylic, LED light
- Side Wall** Hairline stainless steel
- Back Wall** Hairline stainless steel, mirror stainless steel
- Front Wall** Hairline stainless steel
- Handrail** Hairline stainless steel
- Floor** PVC



DC229

- Ceiling** Hewen stainless steel, LED down light, return light strip
- Side Wall** Mirror stainless steel, hewen stainless steel
- Back Wall** Mirror stainless steel, hewen stainless steel
- Front Wall** Hairline stainless steel
- Handrail** Hairline stainless steel
- Floor** Marble



DC004

- Ceiling** Hairline stainless steel, acrylic
- Side Wall** Hairline stainless steel, glass
- Back Wall** Hairline stainless steel, glass
- Handrail** Stainless steel round tube
- Floor** Marble



DC101

- Car Cover** Steel paint and stainless steel coaming, decorative
- Observation Car Wall** Circular 6+6 doubling safety glass (3 pieces)
- Decoration Roof** Steel paint, acrylic lighting, down light
- Car Wall** Hairline stainless steel
- Handrail** Stainless steel single pipe
- Floor** PVC

Specifications of passenger elevator with machine roomless

Load kg	Speed m/s	Car size mm			Door opening size mm		Hoistway size mm			
		CW CW-width	CD CD-depth	CH CH-height	OP OP-width	OPH OPH-height	HW HW-width	HD HD-depth	OH OH-overhead height	PIT PIT-depth
450	1	1000	1300	2380	700	2100	1650	1700	4150	1400
	1.5								4300	1500
	1.75								4400	1550
630	1	1100	1400	2380	700	2100	1750	1800	4150	1400
	1.5				4300		1500			
	1.75				4400		1550			
800	1	1400	1400	2380	800	2100	2050	1800	4150	1400
	1.5								4300	1500
	1.75								4400	1550
1000	1	1600	1400	2380	900	2100	2250	1800	4150	1400
	1.5								4300	1500
	1.75								4400	1550
1150	1	1600	1600	2500	900	2100	2400	2000	4250	1550
	1.5								4400	1700
	1.75								4500	1700
1350	1	2000	1500	2500	1100	2100	3000	2100	4550	1700
	1.5								4650	1750
	1.75								4700	1800
1600	1	2000	1700	2500	1100	2100	3000	2200	4550	1700
	1.5								4650	1750
	1.75								4700	1800

Specifications of passenger elevator with machine room

Load kg	Speed m/s	Car size mm			Door opening size mm		Hoistway size mm			
		CW CW-width	CD CD-depth	CH CH-height	OP OP-width	OPH OPH-height	HW HW-width	HD HD-depth	OH OH-overhead height	PIT PIT-depth
450	1	1150	1100	2500	700	2100	1600	1750	4250	1400
	1.5								4350	1450
	1.75								4400	1500
630	1	1400	1100	2500	800	2100	1850	1750	4250	1400
	1.5								4350	1450
	1.75								4400	1500
800	1	1400	1400	2500	800	2100	1850	2050	4300	1400
	1.5								4400	1450
	1.75								4450	1500
	2						2000	2050	4800	1750
	2.5								5000	1950
	3								4300	1400
1000	1	1600	1400	2500	900	2100	2050	2050	4400	1450
	1.5								4450	1500
	1.75								4800	1750
	2			2200			2100	5000	1950	
	2.5							4300	1400	
	3							4400	1450	
	4			2300			2300	4450	1500	
	1							4800	1750	
	1.5							5000	1950	
1150	1	1800	1500	2500	1100	2100	2400	2200	4800	1750
	1.5								5000	1950
	1.75								4800	1750
	2		2300	2600			5000	1950		
	2.5						4300	1400		
	3						4400	1450		
	4		2300	2600			4750	1650		
	1						4800	1750		
	1.5						5000	1950		
1350	1	2000	1500	2500	1100	2100	2500	2200	4800	1750
	1.5								5000	1950
	1.75								4800	1750
	2		2300	2600			5000	1950		
	2.5						4300	1400		
	3						4400	1450		
	4		2300	2600			4750	1650		
	1						4800	1750		
	1.5						5000	1950		
1600	1	2000	1700	2500	1100	2100	2500	2400	4800	1750
	1.5								5000	1950
	1.75								4800	1750
	2		2450	2600			5000	1950		
	2.5						4300	1400		
	3						4400	1450		
	4		2500	2600			4750	1650		
	1						4800	1750		
	1.5						5000	1950		

Note: Standard floor height, the first layer of 4m, other floor 3m

The drawings and specifications shown on sample are only for your reference, any order please confirm with Glarie company

GLARIE FREIGHT

Car decoration solution



DC301 Standard configuration

- Ceiling** Ordinary steel plate spraying (P001)
- Car Wall** Ordinary steel plate spraying (P001)
- Floor** Ordinary checkered plate
- Car door** Ordinary steel plate spraying (P001)



GEB Standard configuration

- Ceiling** Hairline stainless steel frame, acrylic lighting (CL001)
- Car Wall** Hairline stainless steel
- Floor** PVC (FR109)
- Car door** Hairline stainless steel

Specification Parameter of freight elevator

Capacity kg	Speed m/s	Car dimension mm			Door opening dimension mm		Hoistway dimension mm				Highest landing	Highest rise height m	Machine room net width mm	Machine room net depth mm	Machine room net height mm
		Car Width	Car Depth	Car Height	Opening Width	Opening Height	Hoistway Width	Hoistway Depth	Overhead	Pit depth					
1000	0.5	1400	1600	2200	1300	2100	2500	2080	4300	1400	8	30	3300	3800	2600
	15										60				
1000	0.5	1700	2400	2200	1500	2100	2800	2880	4300	1400	8	30	3800	4500	2600
	15										60				
2000	0.5	2000	2800	2200	1700	2100	3200	3280	4300	1400	8	30	4000	4500	2600
	15										60				
3000	0.5	2000	3600	2400	2000	2300	3450	4080	4500	1500	4	15	4000	4800	2600
	8										30				
4000	0.25	2400	3600	2400	2200	2300	3750	4080	4500	1500	4	15	4300	5300	2600
	8										30				

Specification Parameter of freight elevator (Machine roomless)

Capacity kg	Speed m/s	Car dimension mm			Door opening dimension mm		Hoistway dimension mm				Highest landing	Highest rise height m
		Car Width	Car Depth	Car Height	Opening Width	Opening Height	Hoistway Width	Hoistway Depth	Overhead	Pit depth		
2000	0.5	1700	2400	2200	Side opening	2100	2800	2900	4500	1500	8	30
Opposite entrances	1500				2100							
3000	0.5	2000	2800	2200	Center opening	2100	3300	3300	4800	1700	8	30
Opposite entrances	1700				2100							

note: Standard floor height is 4 meters
The drawings and specifications shown on sample are only for your reference, any order please confirm with Glarie company

Specification parameter of hospital elevator

Capacity kg	Speed m/s	Car dimension mm			Door opening dimension mm		Hoistway dimension mm			
		Car Width	Car Depth	Car Height	Opening Width	Opening Height	Hoistway Width	Hoistway Depth	Overhead height	Pit depth
1600	1	1400	2400	2500	1100 (Center opening)	2100	2500	2850	4450	1550
	1.5								4600	1600
	1.75								4650	1650
1600	1	1400	2400	2500	1200 (Side opening)	2100	2300	2850	4450	1550
	1.5								4600	1600
	1.75								4650	1650

Note: Standard floor height, the first layer of 4m, other floor 3m
The drawings and specifications shown on sample are only for your reference, any order please confirm with Glarie company

GLARIE HOME LIFT IN SEARCH OF YOUR DREAM LIFE



HOME ELEVATOR

Car decoration

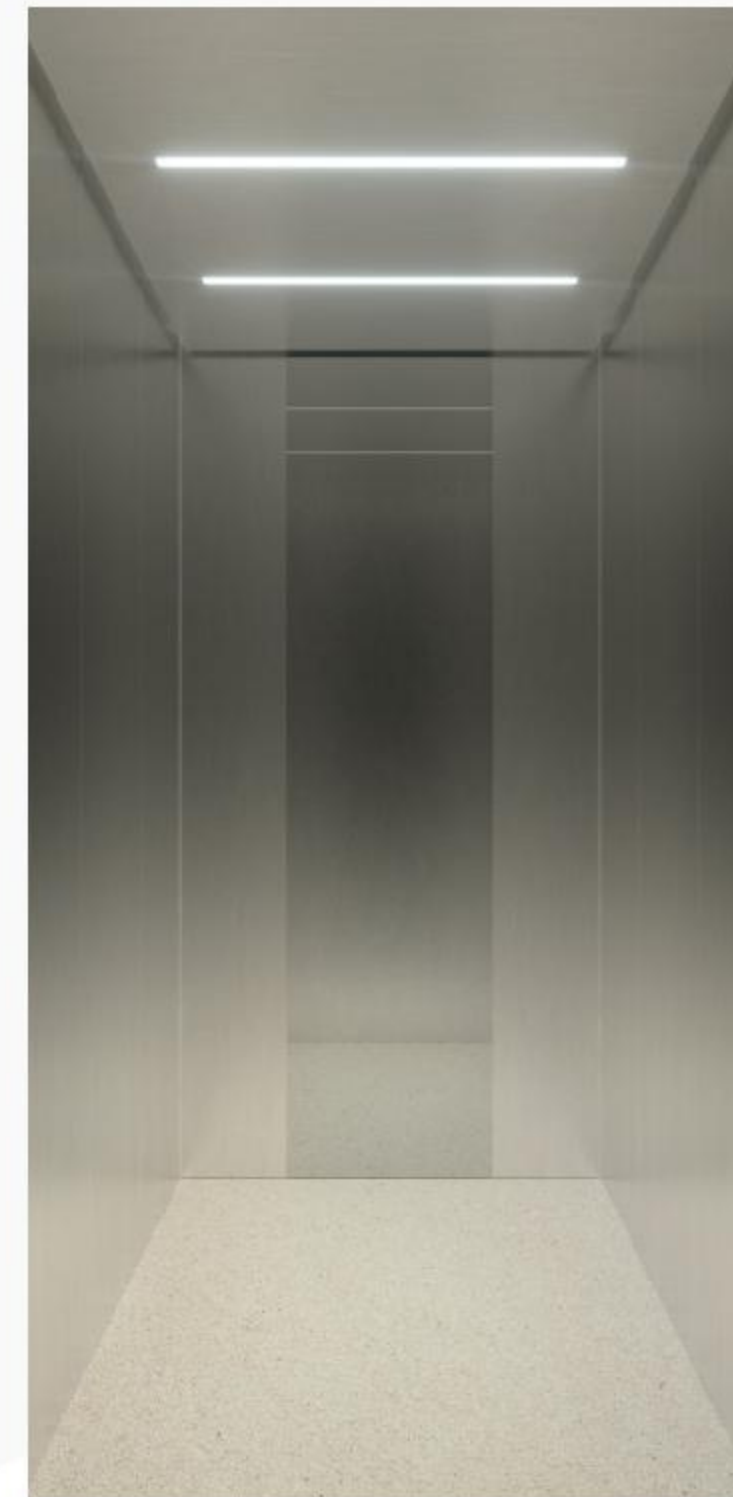

◀ HC165

Ceiling Hairline st st, downlight, HCL001
Car Wall Hairline st st
Floor PVC



◀ HC118

Ceiling White paint shape, LED downlight, light strip
Side wall Wood grain fireproof board, mirror st st etching, brushed st st edge strip, brushed st st baseboard
Back wall Wood grain fireproof board, mirror st st etching, brushed st st edge trim, brushed st st skirting
Front wall Mirror st st
Floor Marble



◀ HC119

Ceiling White paint, LED downlight, light strip mirror st st
Side wall Leather grain fireproof board, mirror st st etching, brushed st st edge strip, brushed st st baseboard
Back wall Leather grain fireproof board, mirror st st etching, brushed st st edge trim, brushed st st skirting
Front wall Mirror st st
Floor Marble



◀ HC145

Ceiling Acrylic, LED down light, rose gold mirror st st
Car wall Rose gold hairline st st, colored steel plate
Front wall Rose gold hairline st st
Floor Marble



◀ HC146

Ceiling Hairline st st, LED down light
Car wall Hairline st st, glass
Front wall Hairline st st
Floor Marble

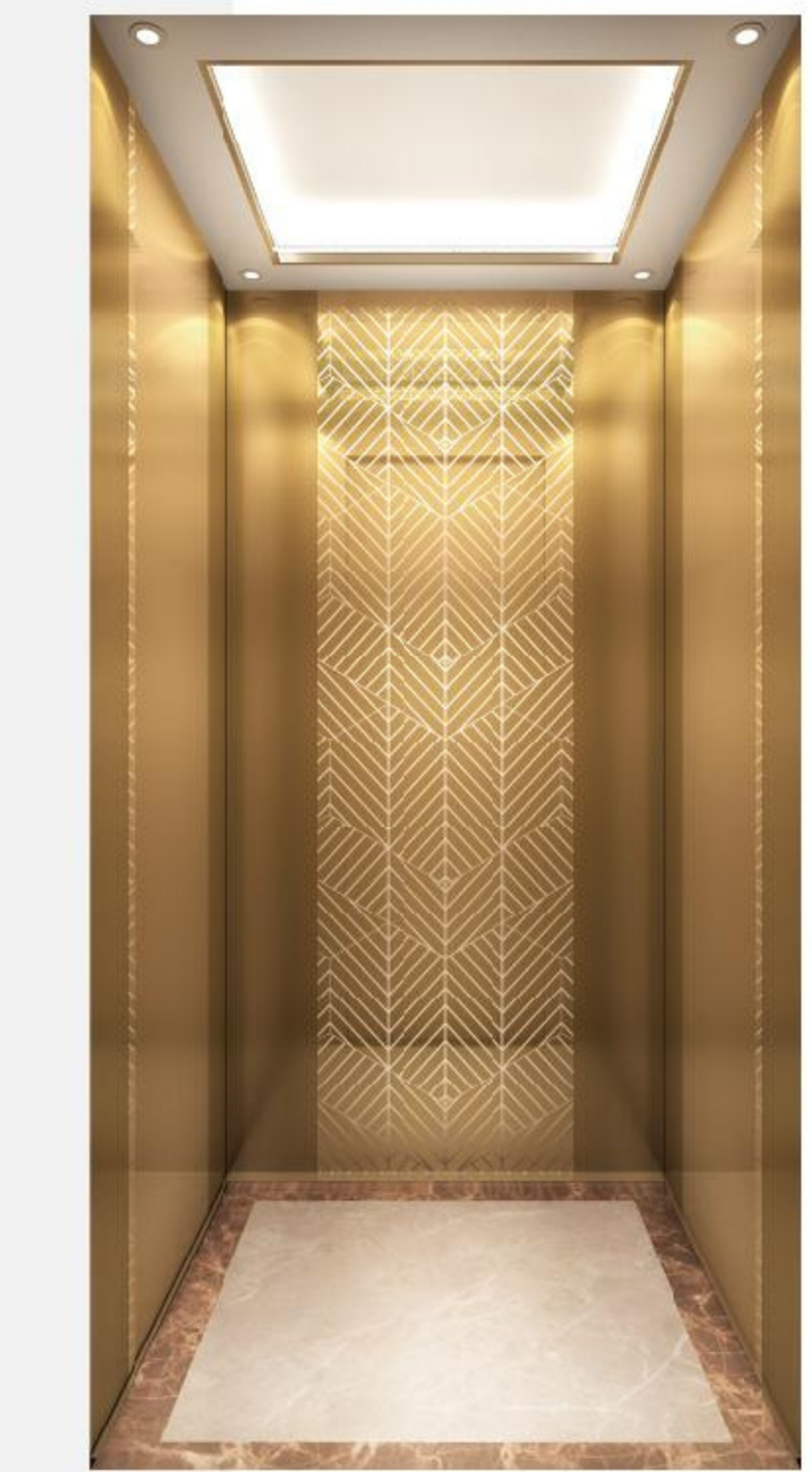

◀ HC152

Ceiling Spray steel plate, rose gold hairline st st, downlight, return light strip
Car wall Rose gold mirror st st, mirror st st etched rose gold plated rose gold, hairline st st
Front wall Rose gold hairline st st
Floor Marble



◀ HC132

Ceiling Titanium mirror st st, downlight
Side wall Titanium mirror st st etching, titanium mirror st st
Back wall Titanium mirror st st etching, titanium mirror st st
Front wall Titanium mirror st st
Floor PVC

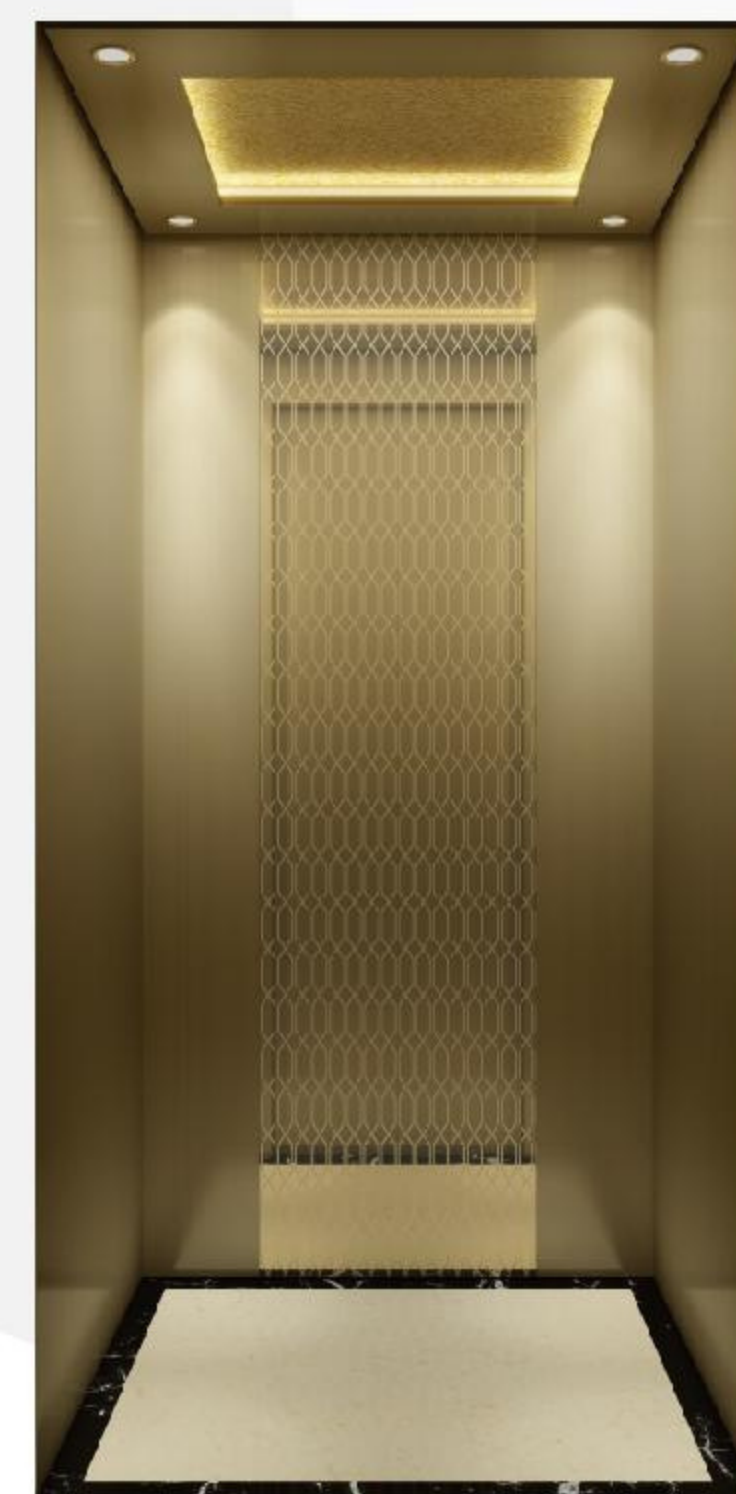

◀ HC142

Ceiling Gold foil, light belt, LED down light, champagne gold hairline st st
Car wall Champagne gold hairline st st, champagne gold mirror etching stainless
Front wall Champagne gold hairline st st
Floor Marble



◀ HC143

Ceiling Acrylic, LED down light, bronze hairline st st
Car wall Bronze hairline st st, bronze mirror st st etching
Front wall Bronze hairline st st
Floor Marble



◀ HC153

Ceiling Spray steel plate, champagne gold hairline st st, downlight, return light strip
Car wall Champagne gold mirror st st, color pattern steel plate, mirror st st etched champagne gold plated
Front wall Champagne gold hairline st st
Floor Marble

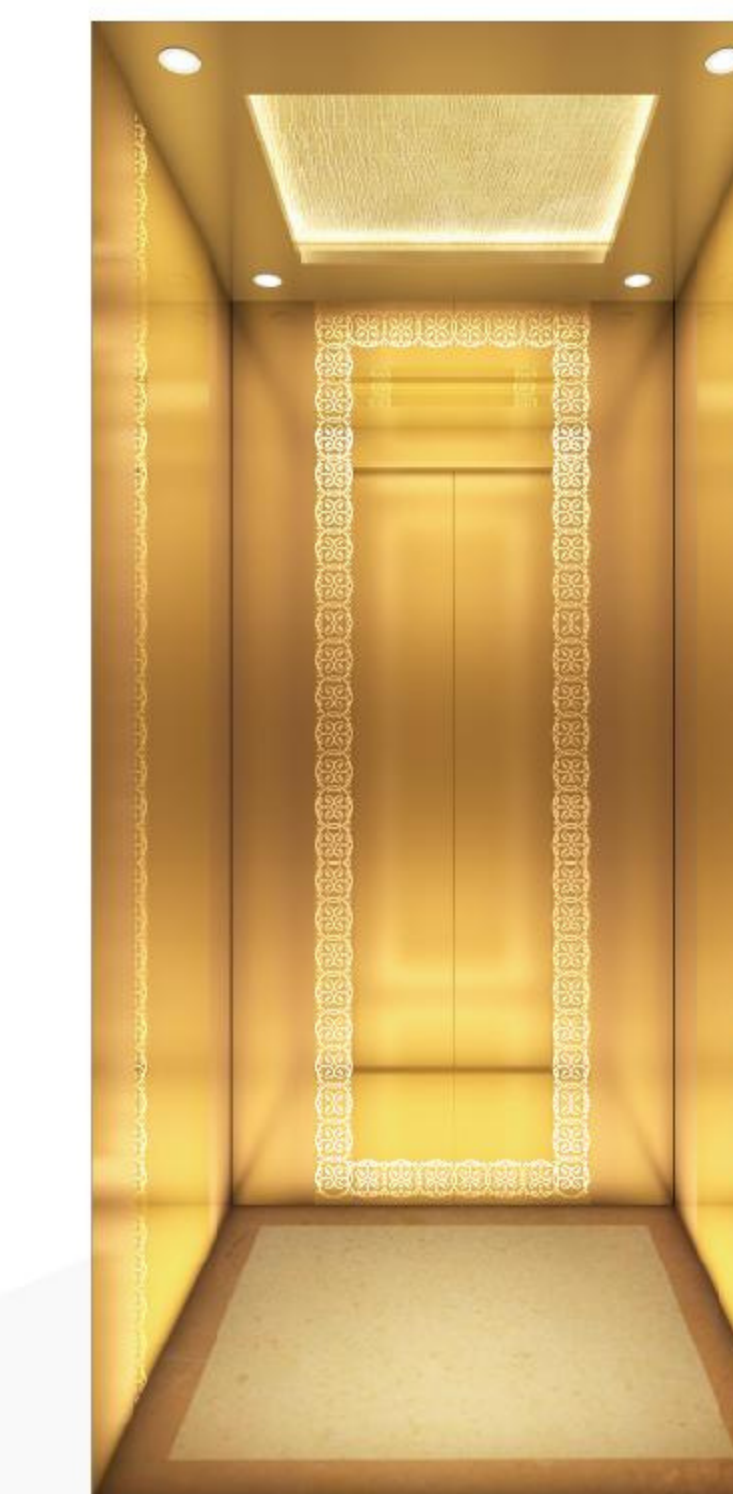

◀ HC155

Ceiling Rose gold hairline st st, LED downlight, back light strip, gold leaf
Car wall Mirror st st with etched rose gold plating, rose gold hairline st st, rose gold mirror st st
Front wall Rose gold hairline st st
Floor Marble

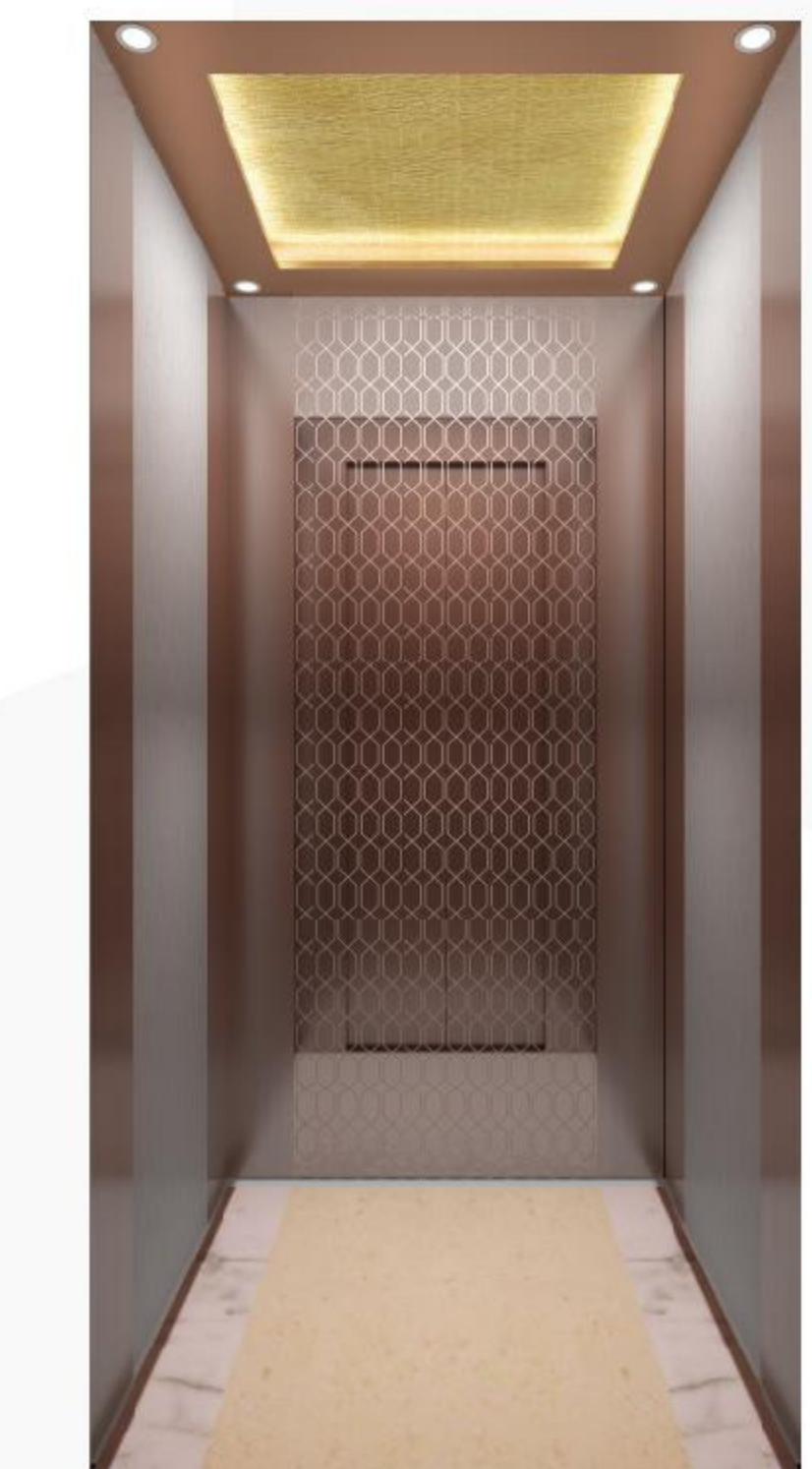

◀ HC156

Ceiling Rose gold mirror st st, LED downlight, back light strip, gold leaf
Car wall Rose gold hairline st st, color pattern steel plate, mirror st st etched rose gold plated
Front wall Rose gold hairline st st
Floor Marble

HOME ELEVATOR

Car decoration



◀ HC158

Ceiling Bronze hairline st st, LED lamp
Side wall Anti-fingerprint of sandblast st st
Back wall Anti-fingerprint of bronze etched mirror st st, anti-fingerprint of sandblast st st
Front wall Anti-fingerprint of sandblast st st
Floor Marble



◀ HC159

Ceiling Baking painted st, LED light
Side wall Anti-fingerprint of champagne gold hairline st st
Back wall Etched mirror st st, mirror st st
Front wall Anti-fingerprint of champagne gold hairline st st
Floor Marble

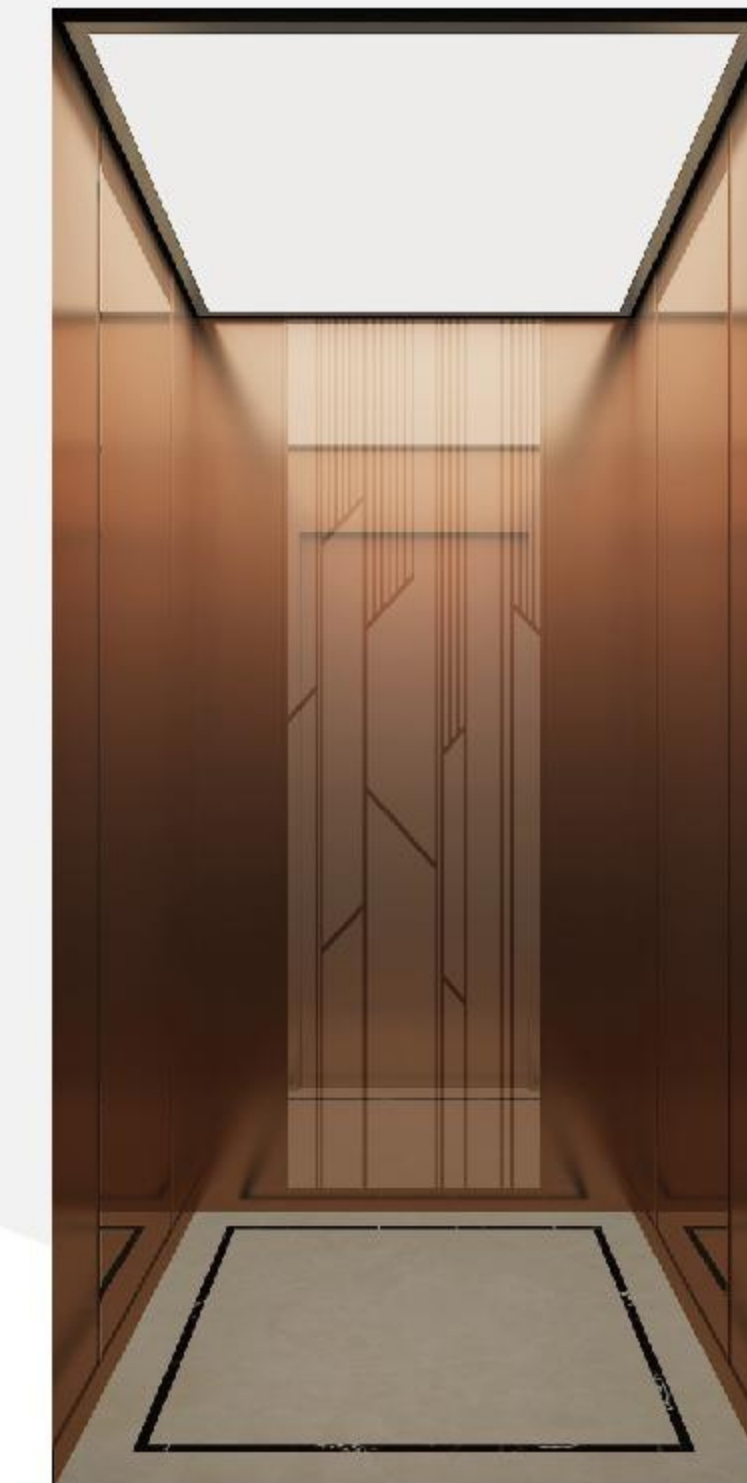

◀ HC160

Ceiling LED flat light
Side wall Anti-fingerprint of rose gold hairline st st
Back wall Etched rose mirror st st, anti-fingerprint of rose gold hairline st st
Front wall Anti-fingerprint of rose gold hairline st st
Floor Marble

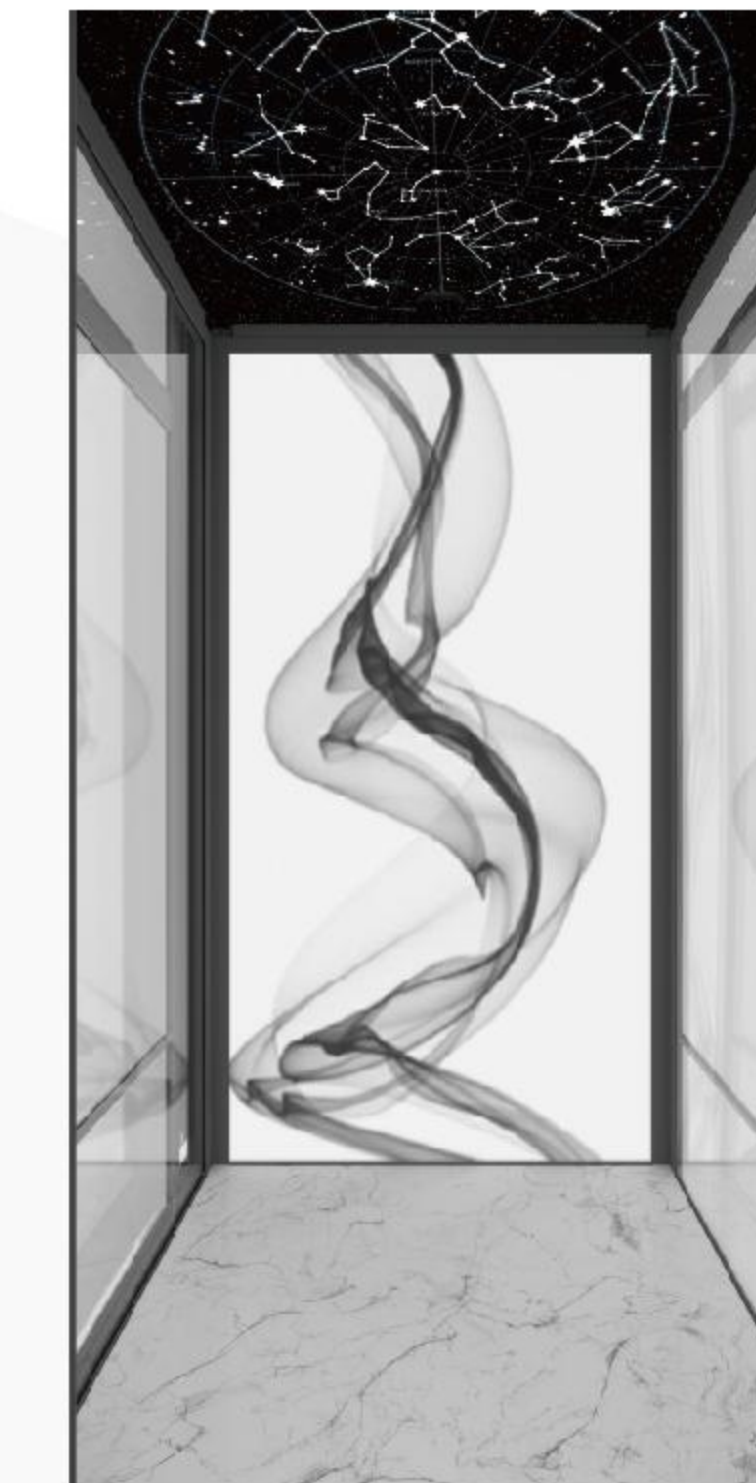

◀ HCS501

Ceiling Starry ceiling
Side wall Glass
Back wall Art glass
Floor Marble

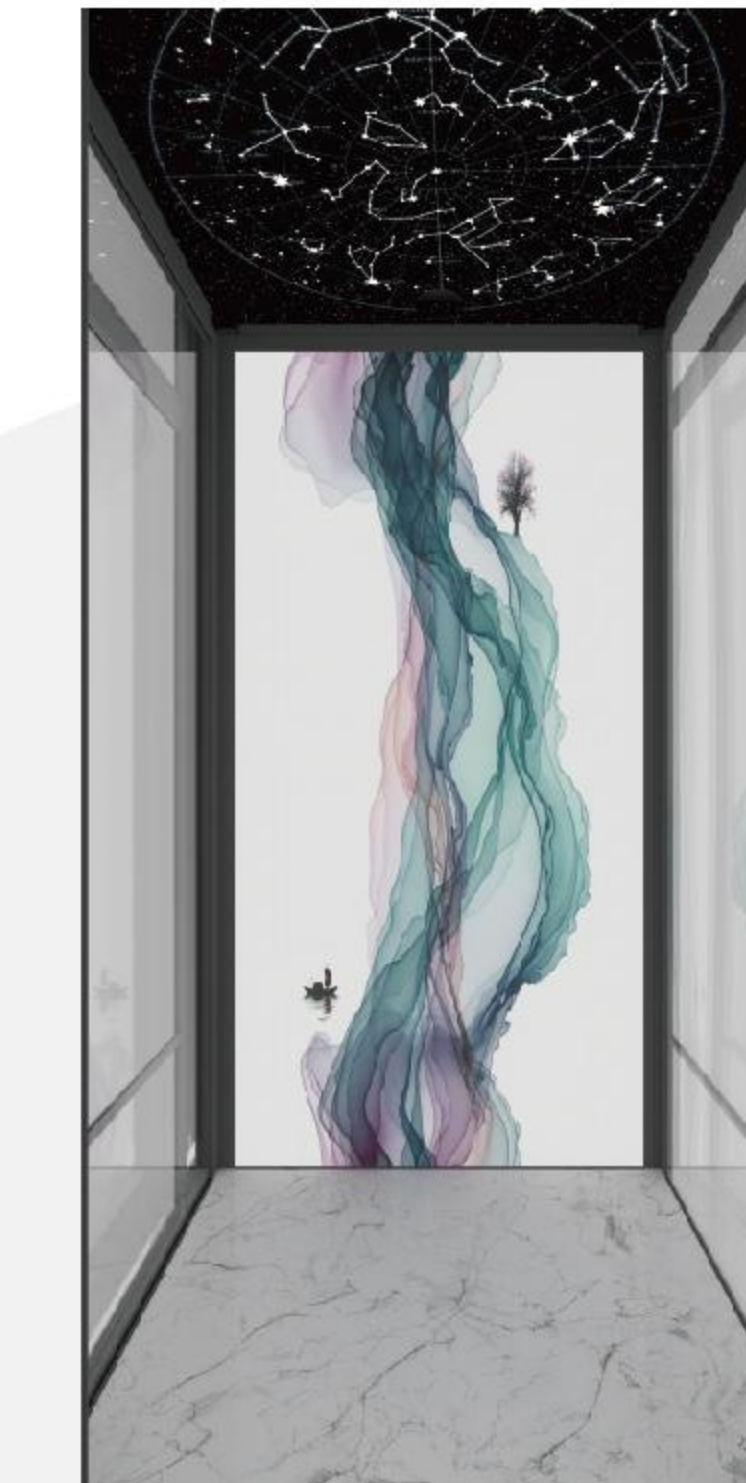

◀ HCS507

Ceiling Starry ceiling
Side wall Glass
Back wall Art glass
Floor Marble



◀ HCS509

Ceiling LED flat light
Side wall 5+5 tempered laminated glass middle with mirror St St
Back wall 5+5 tempered laminated glass
Front wall Mirror St St
Floor Marble



◀ HC162

Ceiling LED flat light
Side wall 443 anti-fingerprint of hairline st st
Back wall 443 anti-fingerprint of hairline st st, mirror st st
Front wall 443 anti-fingerprint of hairline st st
Floor PVC



◀ HCM301

Ceiling Rose gold hairline st st, Acrylic transparent plate
Side wall Anti-fingerprint of rose gold hairline st st
Back wall Anti-fingerprint of rose gold hairline st st, mirror st st
Front wall Anti-fingerprint of rose gold hairline st st
Floor Terrazzo

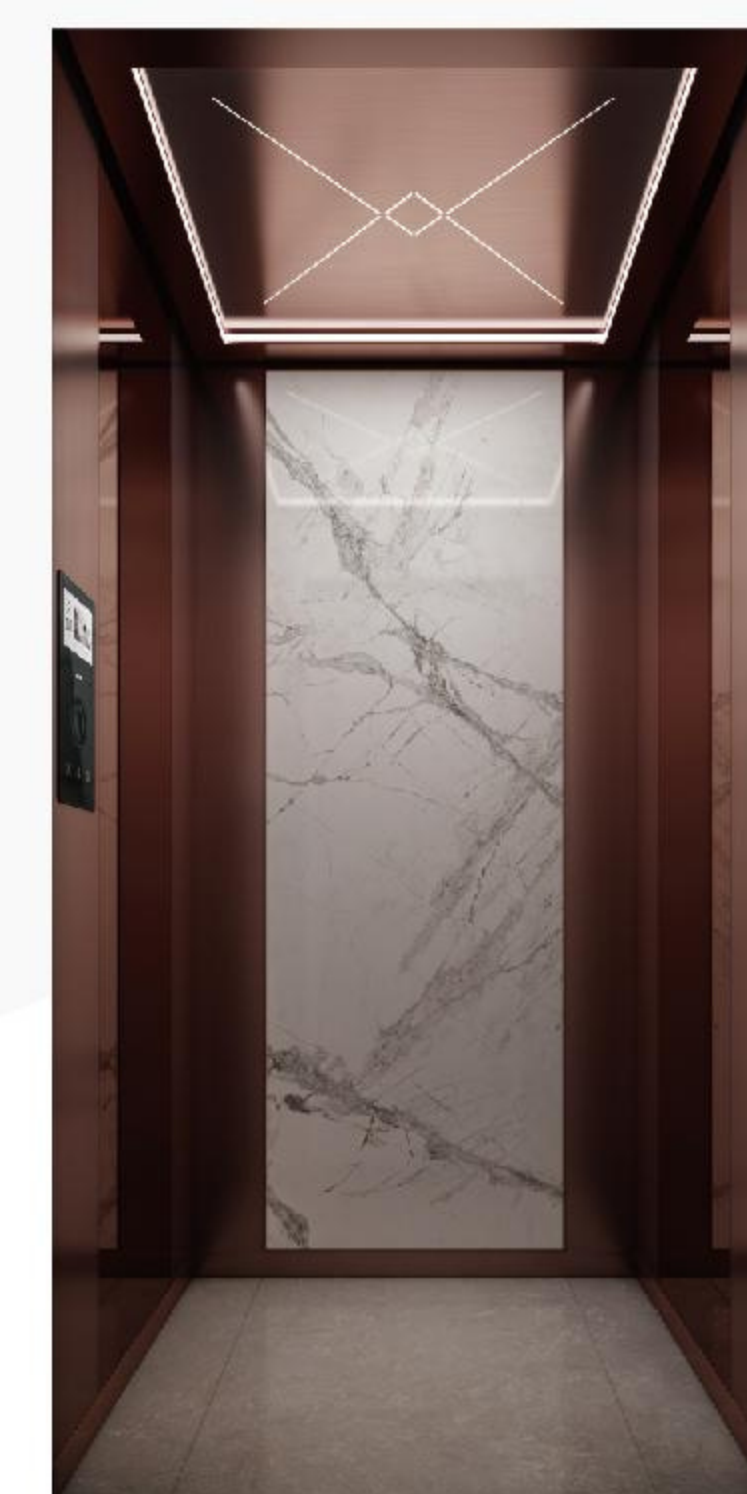

◀ HCM305

Ceiling Dark brown hairline st st, laser cutting modeling light
Side wall Dark brown mirror st st, anti-fingerprint of dark brown hairline st st
Back wall Ceramic sheet, dark brown in the middle, anti-fingerprint of hairline st st with decorative strip
Front wall Anti-fingerprint of dark brown hairline st st
Floor Marble

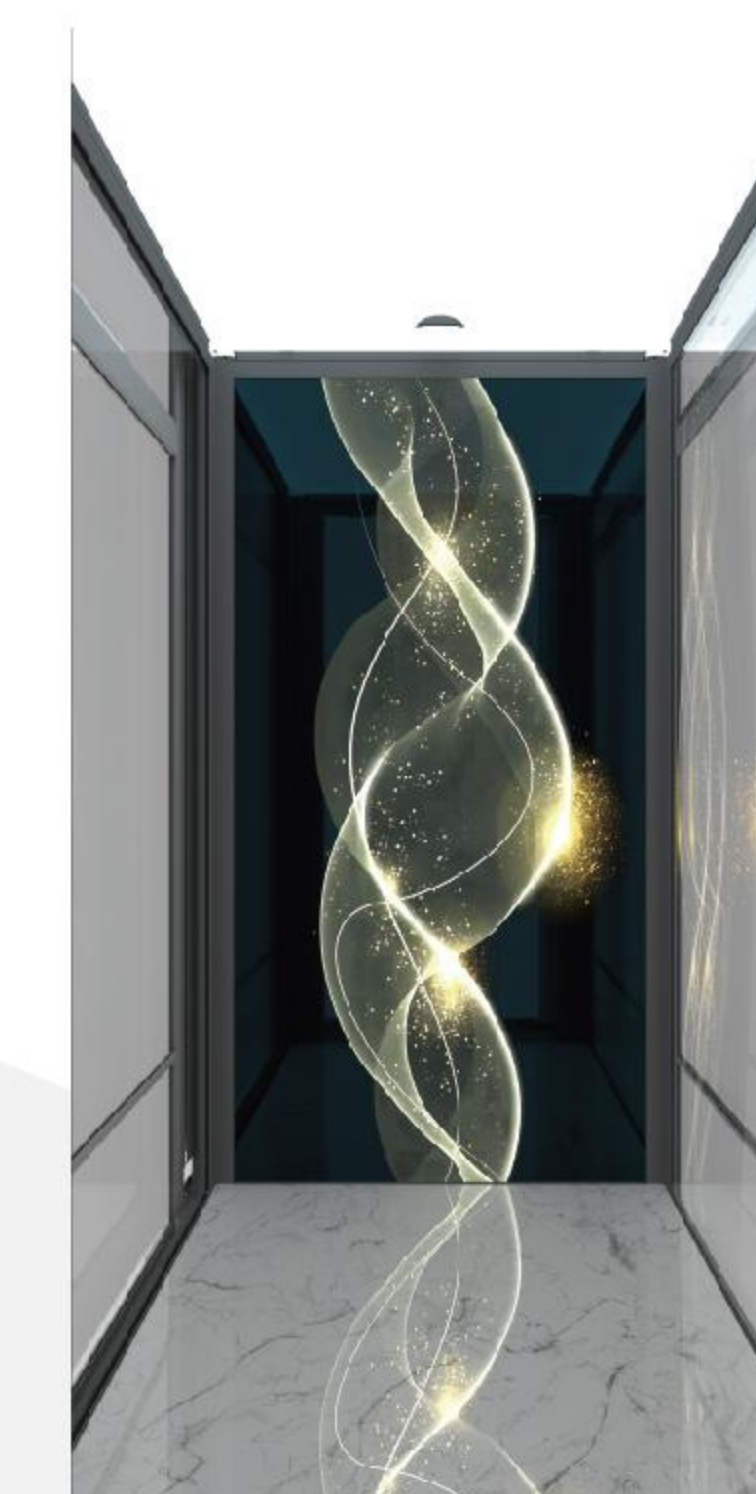

◀ HCS510

Ceiling LED flat light
Side wall Glass
Back wall Art glass
Floor Marble

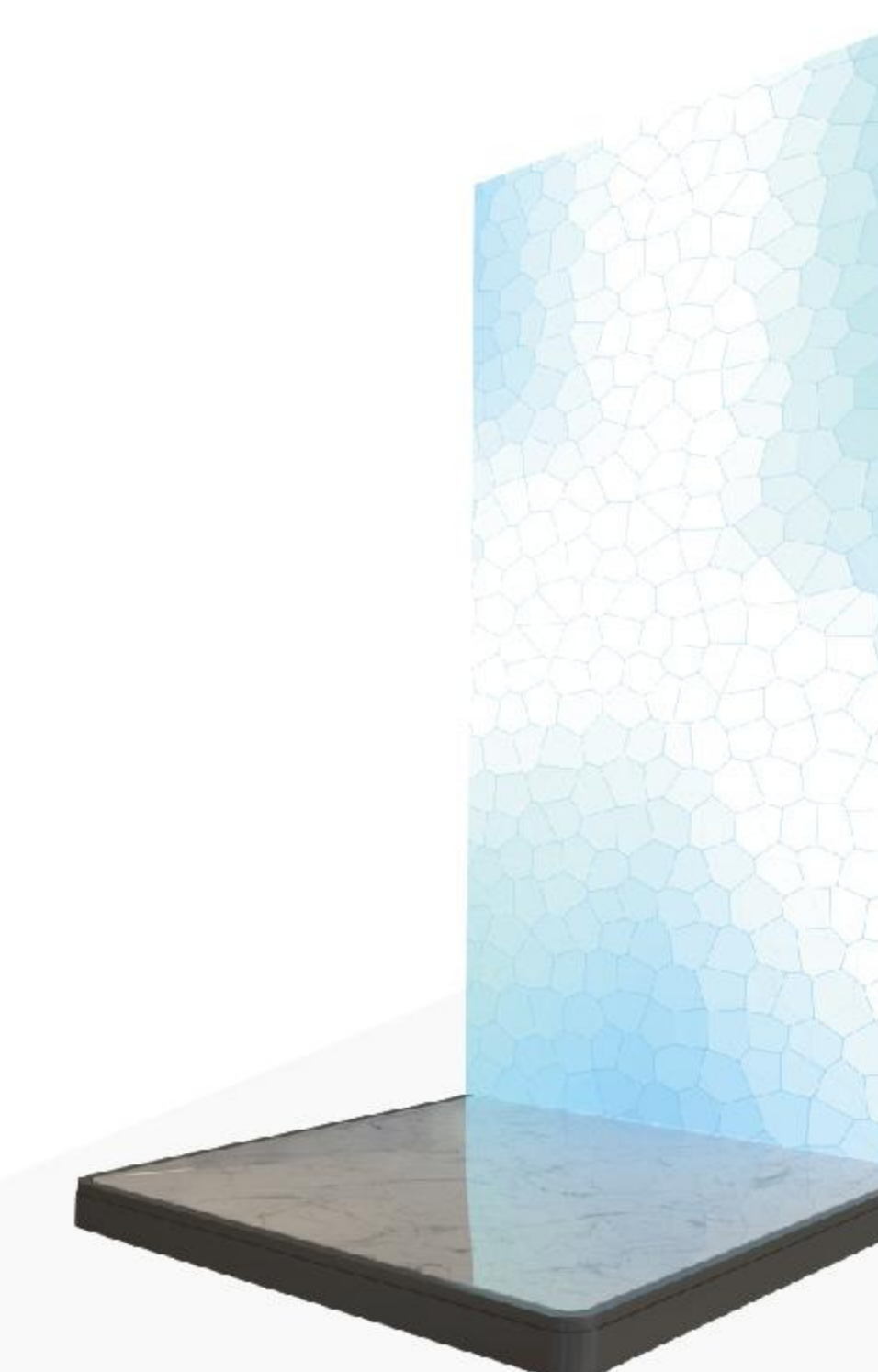

◀ HPT003

Back wall Luminous
Floor Marble



◀ HPT005

Back wall Luminous
Floor Marble

GLARIE HOME LIFT IN SEARCH OF YOUR DREAM LIFE

Specification Parameter of Home Elevator (Concrete/steel)

GEH220S

Load kg	Speed m/s	Car size (mm)			Door opening size (mm)		Hoistway size (mm)				
		CW Width	OD Depth	CH Height	OP Width	OPH Height	HW Width	HD Depth	OH Overhead height	PIT Pit depth	R Travel height
400	0.4	950	880	2200	650	2000	1400	1100	2850	250	≤12000
400	0.4	1200	1280	2200	700	2000	1700	1500	2850	250	≤12000

GEH260

Load kg	Speed m/s	Car size (mm)			Door opening size (mm)		Hoistway size (mm)				
		CW Width	OD Depth	CH Height	OP Width	OPH Height	HW Width	HD Depth	OH Overhead height	PIT Pit depth	R Travel height
250	0.4	1000	930	2200	700	2000	1600	1200	2600	350	≤12000
320	0.4	1000	1080				1600	1350			
400	0.4	1000	1280				1600	1550			

GEH320S

Load kg	Speed m/s	Car size (mm)			Door opening size (mm)		Hoistway size (mm)				
		CW Width	OD Depth	CH Height	OP Width	OPH Height	HW Width	HD Depth	OH Overhead height	PIT Pit depth	R Travel height
400	0.4	950	800	2200	650	2000	1450	1100	2850	250	≤12000
400	0.4	1200	1280	2200	700	2000	1750	1500	2850	250	≤12000

GEH500

Load kg	Speed m/s	Car size (mm)			Door opening size (mm)		Hoistway size (mm)				
		CW Width	OD Depth	CH Height	OP Width	OPH Height	HW Width	HD Depth	OH Overhead height	PIT Pit depth	R Travel height
350	0.3	800	600	2150	650	2000	1000	1000	2650	100	≤12000
350	0.3	1200	1000	2150	850	2000	1400	1400	2650	100	≤12000

NOTE: Above shaft materials with concrete/steel

Specification Parameter of Home Elevator (Aluminum structure)

GEH220S

Load kg	Speed m/s	Car size (mm)			Door opening size (mm)		Hoistway size (mm)				
		CW Width	OD Depth	CH Height	OP Width	OPH Height	HW Width	HD Depth	OH Overhead height	PIT Pit depth	R Travel height
400	0.4	950	930	2200	650	2000	1550	1300	2850	250	≤12000
400	0.4	1200	1280	2200	700	2000	1850	1650	2850	250	≤12000

GEH260

Load kg	Speed m/s	Car size (mm)			Door opening size (mm)		Hoistway size (mm)				
		CW Width	OD Depth	CH Height	OP Width	OPH Height	HW Width	HD Depth	OH Overhead height	PIT Pit depth	R Travel height
250	0.4	1000	930	2200	700	2000	1750	1350	2600	350	≤12000
320	0.4	1000	1080				1750	1500			
400	0.4	1000	1280				1750	1700			

GEH320S

Load kg	Speed m/s	Car size (mm)			Door opening size (mm)		Hoistway size (mm)				
		CW Width	OD Depth	CH Height	OP Width	OPH Height	HW Width	HD Depth	OH Overhead height	PIT Pit depth	R Travel height
400	0.4	950	930	2200	650	2000	1600	1300	2850	250	≤12000
400	0.4	1200	1280	2200	700	2000	1900	1650	2850	250	≤12000

GEH500

Load kg	Speed m/s	Car size (mm)			Door opening size (mm)		Hoistway size (mm)				
		CW Width	OD Depth	CH Height	OP Width	OPH Height	HW Width	HD Depth	OH Overhead height	PIT Pit depth	R Travel height
350	0.3	800	600	2150	650	2000	1000	1000	2650	100	≤12000
350	0.3	1200	1000	2150	850	2000	1400	1400	2650	100	≤12000

SLP500

Load kg	Speed m/s	Car size (mm)			Door opening size (mm)		Hoistway size (mm)				
		CW Width	OD Depth	CH Height	OP Width	OPH Height	HW Width	HD Depth	OH Overhead height	PIT Pit depth	R Travel height
350	0.3	850	650	-	650	2000	965	1150	2700	100	≤12000
350	0.3	1200	950	-	800	2000	1315	1450	2500	100	≤12000

NOTE: Above shaft size included aluminum structure

GLARIE ELEVATOR

Elevator Decoration Series

▶ Landing door series



LD106 Mirror etched St St LD107 Mirror etched St St LD608 Champagne gold mirror etched St St LD509 Rose gold mirror etched St St LD410 Black titanium mirror etched St St LD311 Bronze mirror etched St St LD201 Titanium mirror etched St St

More options for each model: Mirror etched St St, Champagne gold mirror etched St St, Rose gold mirror etched St St, Black titanium mirror etched St St, Bronze mirror etched St St; Titanium mirror etched St St.

▶ PVC floor

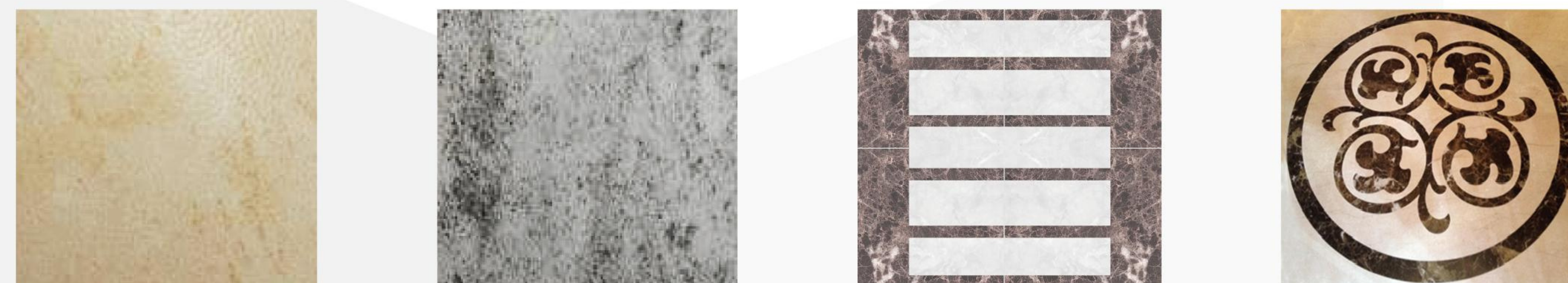

FR101 FR102 FR114 FR107

▶ Marble floor

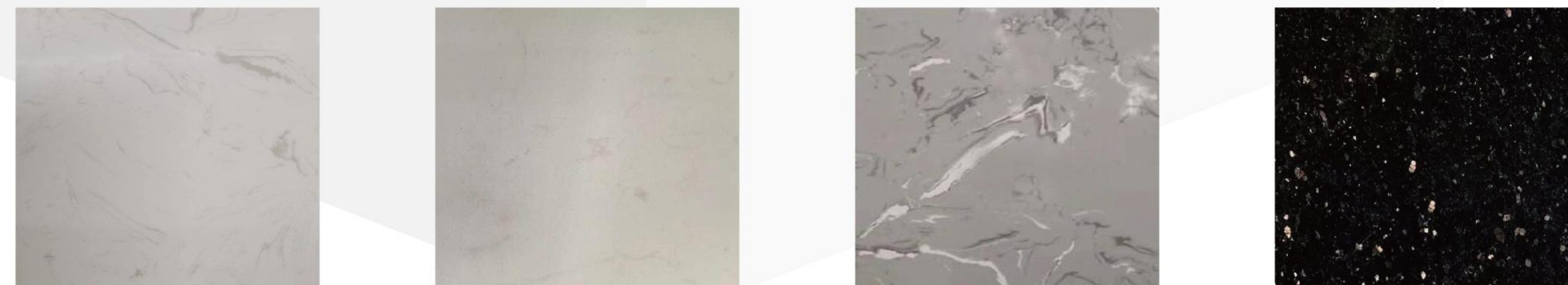

FR034 FR035 FR036 FR037

▶ Floor (Apply to hospital elevator)



FR109 FR0110 FR111 FR112

▶ Riffed plate (Apply to freight elevator)



FR201

▶ Manual door (Suitable for home elevators)



Gentleman grey Dark black Glorious gold Alpine white

Note: more color options refer to aluminum profile frame.

▶ Automatic swing door

▶ Aluminum profile frame shaft

GLASS



ALUMINUM PROFILE FRAME

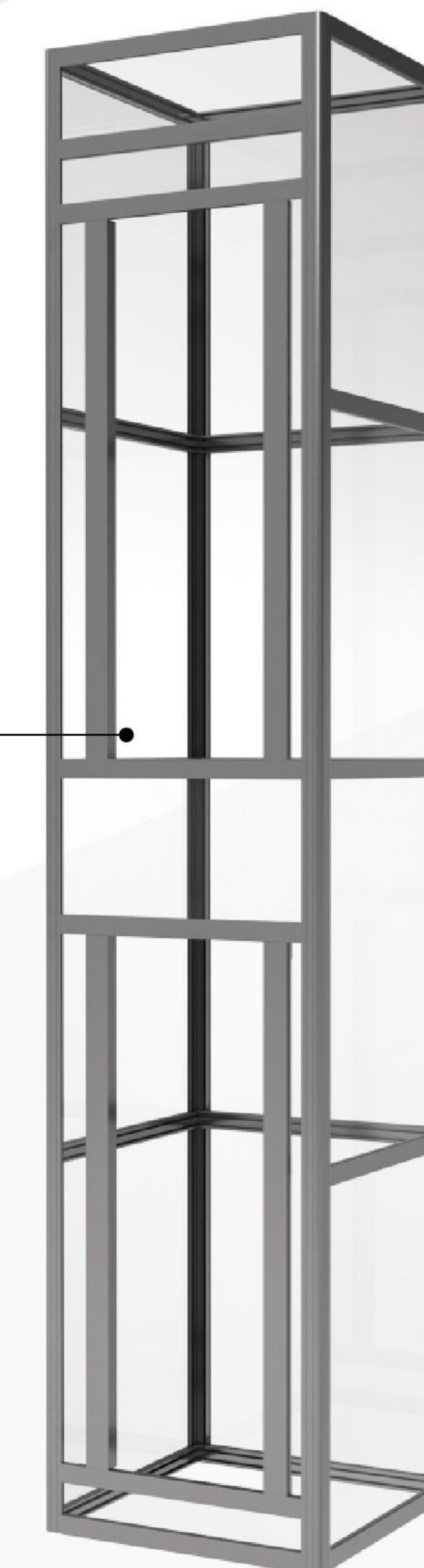

PASSENGER ELEVATOR

Elevator Decoration Series

► Landing door series



COP004C
black and white word break code, liquid-crystal display (optional), standard button B007C

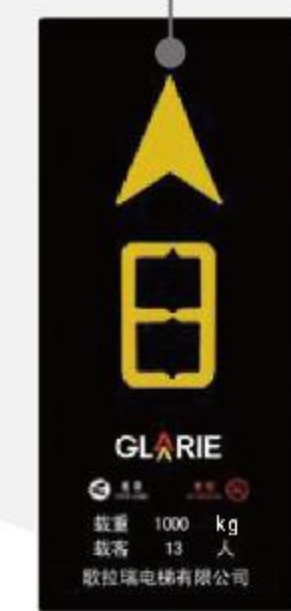

COP004B
black and white word break code, liquid-crystal display (optional)

► COP004A Standard

Material quality Aluminum frame, hairline stainless steel panel

Display Orange dot matrix display (optional: COP004B black and yellow word break code, liquid-crystal display- COP004C black and white word break code, liquid-crystal display)

Button B007A (more options on the button page)



COP005B
black and yellow word break code, liquid-crystal display (optional), button B001A



COP005C
black and yellow word break code, liquid-crystal display (optional) button B001C

► COP005A Optional

Material quality Aluminum frame, hairline stainless steel panel

Display Orange dot matrix display

Button B001A (more options on the button page)

► Ceiling

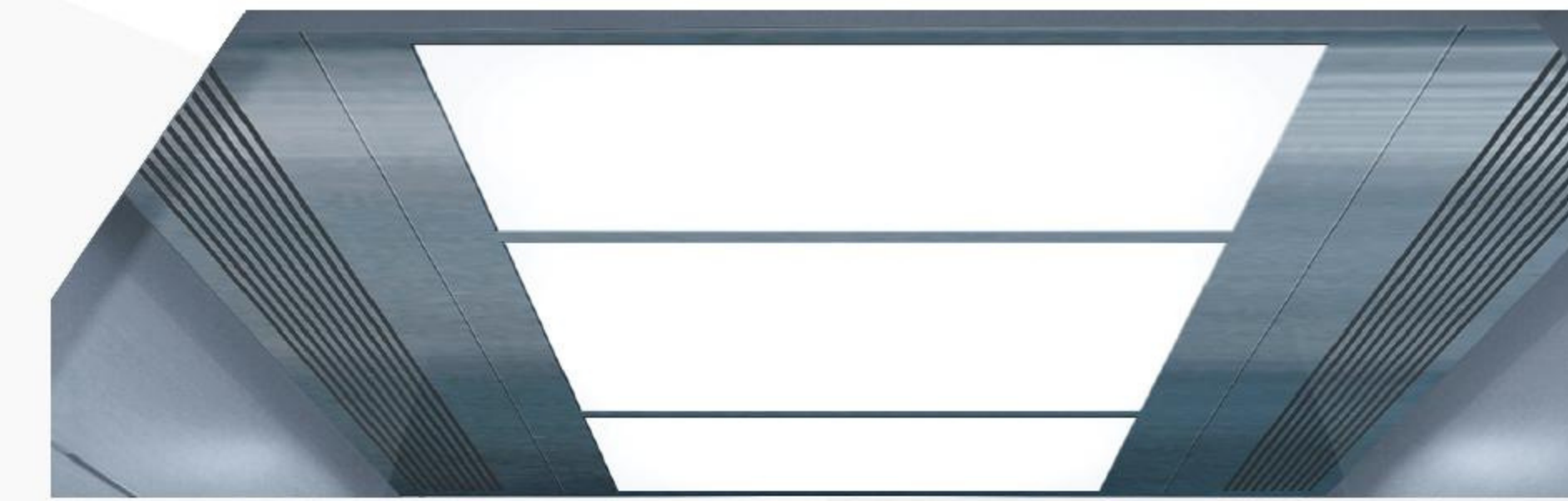

CL001 (Standard)
Hairline stainless steel frame, acrylic lighting

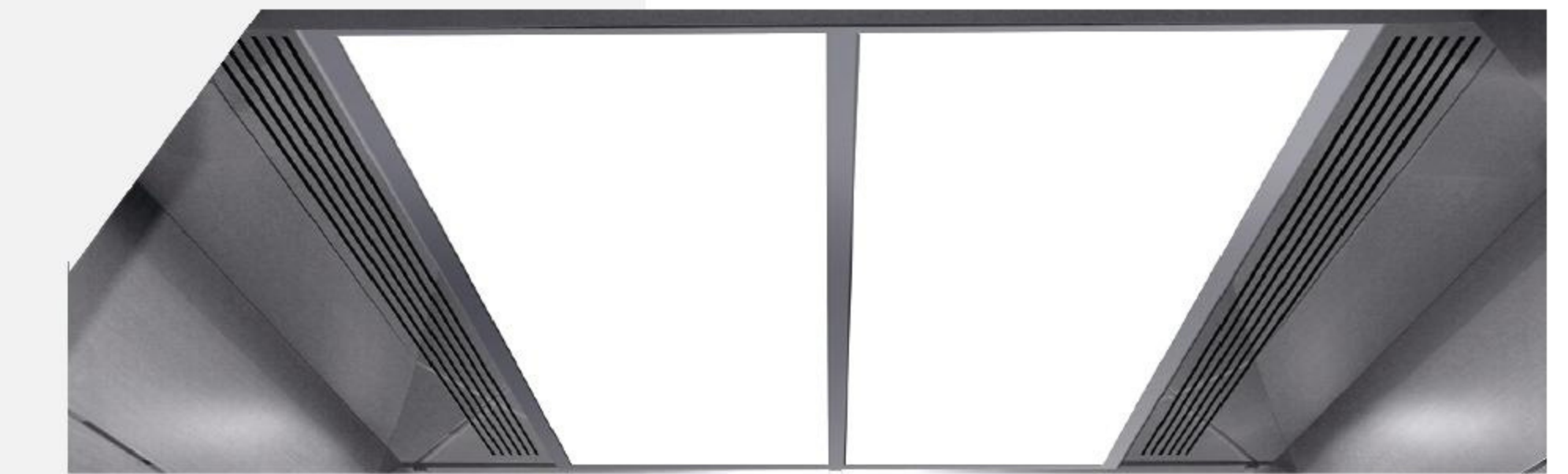

CL002 (Standard)
Hairline stainless steel frame, acrylic lighting

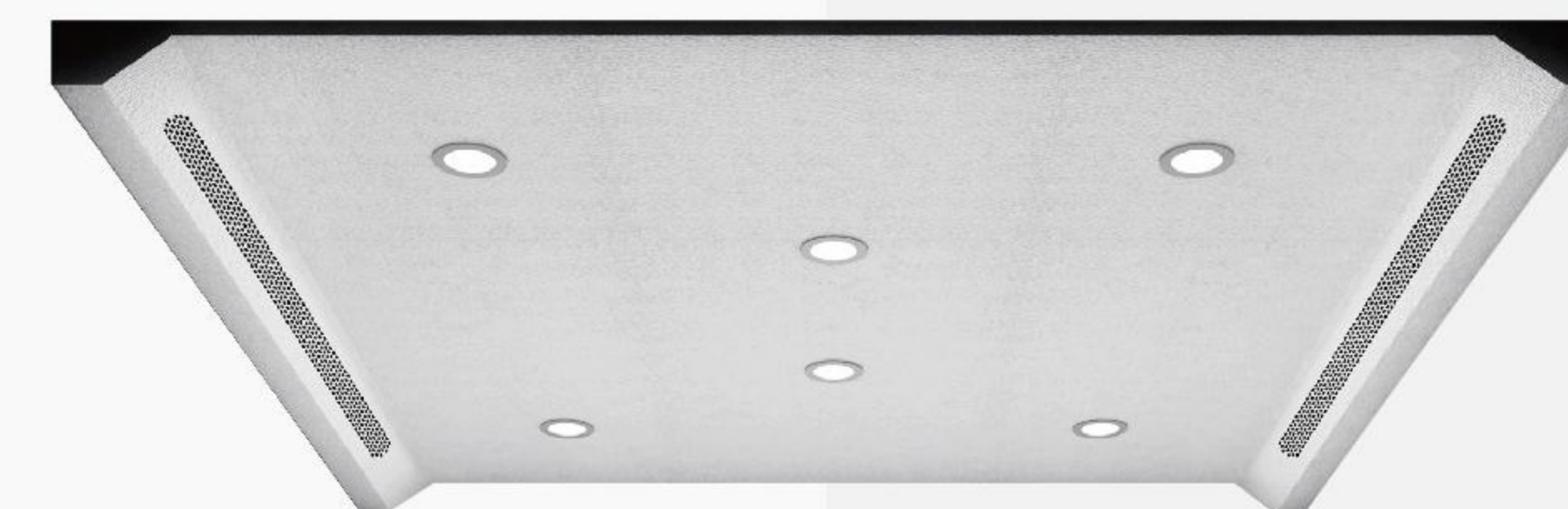

CL006 (Optional)
Powdered hammer RAL9006 suitable for load ≤ 1000kg



CL007 (Optional)
Powdered hammer RAL9003 suitable for load ≤ 1000kg

► Handrail



HR001

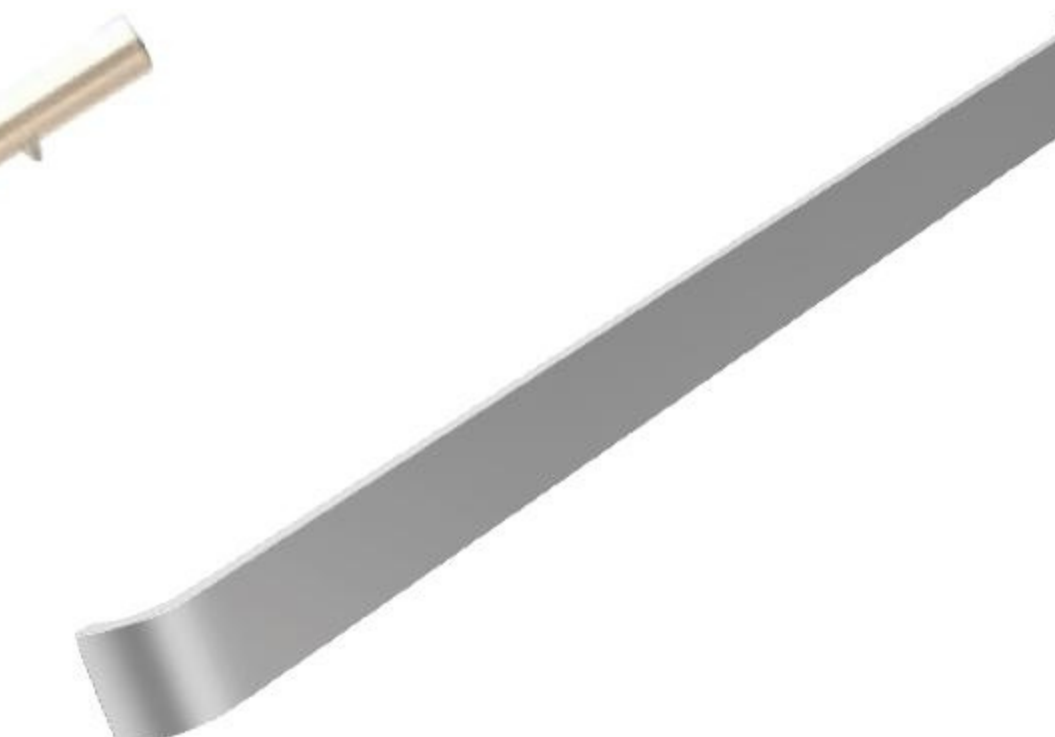

HR002



HR003



HR004

► Spraying color

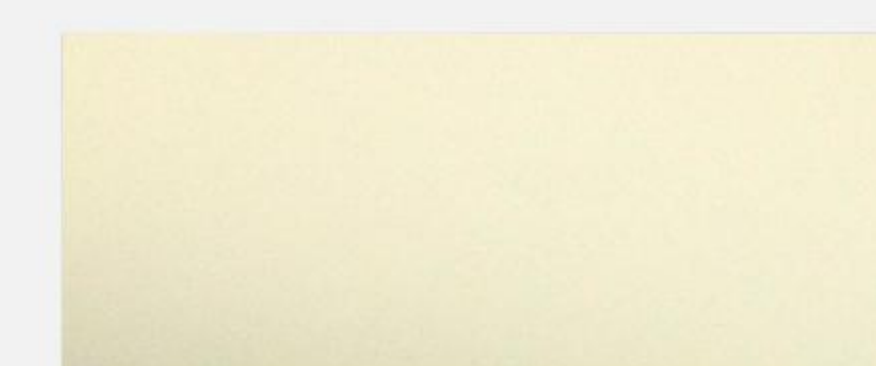

P001
Milky-white

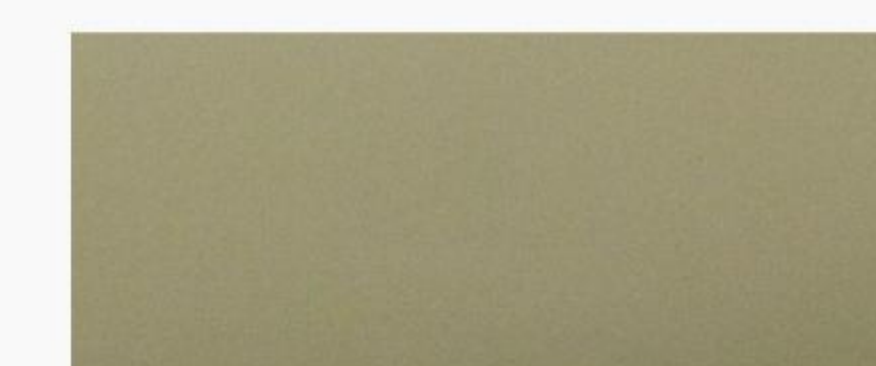

P002
Camel gray

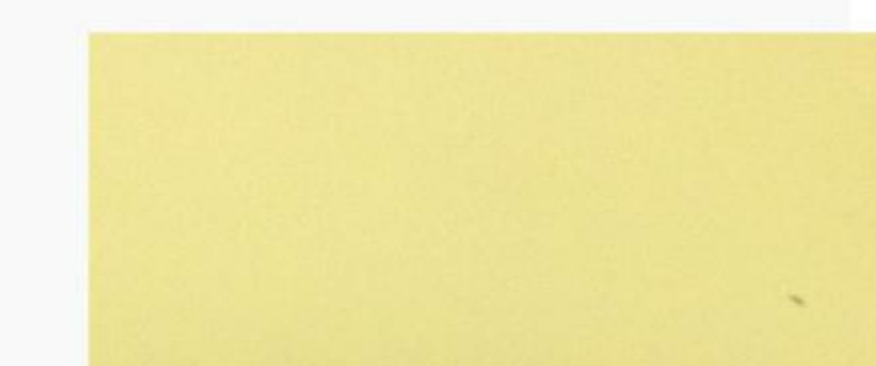

P003
Ivory tint



P004
Aircraft gray

PASSENGER ELEVATOR

Signal Device Series

Optional display



Black and yellow word break code, liquid-crystal display



Black and white word break code, liquid-crystal display

HB006



Material quality Aluminum frame, hairline stainless steel panel
Button B001A (more options on the button page)

Button



B001A
With braille, orange light
B001B
With braille, blue light
B001C
With braille, white light

B101A
With braille, orange light
B101B
With braille, blue light
B101C
With braille, white light



B002A
With braille, orange light
B002B
With braille, blue light
B002C
With braille, white light

B102A
With braille, orange light
B102B
With braille, blue light
B102C
With braille, white light

HB009A (Standard) /HB009B/HB009C



Material quality Aluminum frame, hairline stainless steel panel
Display Orange dot matrix display HB009A (optional: HB009 black and yellow word break code, liquid-crystal display, standard button B007C)
Button B007A (more options on the button page)

HB109A (Standard) /HB109B/HB109C



Material quality Aluminum frame, hairline stainless steel panel
Display Orange dot matrix display HB109A (optional: black and yellow word break code, liquid-crystal display, standard button B007C)
Button B007A (more options on the button page)



B004A
With braille, orange light
B004B
With braille, blue light
B004C
With braille, white light

B104A
With braille, orange light
B104B
With braille, blue light
B104C
With braille, white light



B005A
With braille, orange light
B005B
With braille, blue light
B005C
With braille, white light

B105A
With braille, orange light
B105B
With braille, blue light
B105C
With braille, white light

HBK002A



Material quality Without aluminum frame, hairline stainless steel panel
Display Orange dot matrix display
Button B001A (more options on the button page)
Other Card reader

HB012C



Material quality Aluminum frame, hairline stainless steel panel
Display Black and White word break code, liquid-crystal display



B007A
With braille, orange light
B007B
With braille, blue light
B007C
With braille, white light

B107A
With braille, orange light
B107B
With braille, blue light
B107C
With braille, white light



B008A
With braille, orange light
B008B
With braille, blue light
B008C
With braille, white light

B108A
With braille, orange light
B108B
With braille, blue light
B108C
With braille, white light

Note : Besides indicating the standard, other are optional

HOME ELEVATOR

Human-Computer Interaction Series

► Operating panel



HOP014
Integrated

HOP015
Integrated

HOP017
Standard Material:
Hairline
Optional Material:
Mirror, Bronze, Titanium,
Rose Gold, Champagne Gold



HOP027
Optional

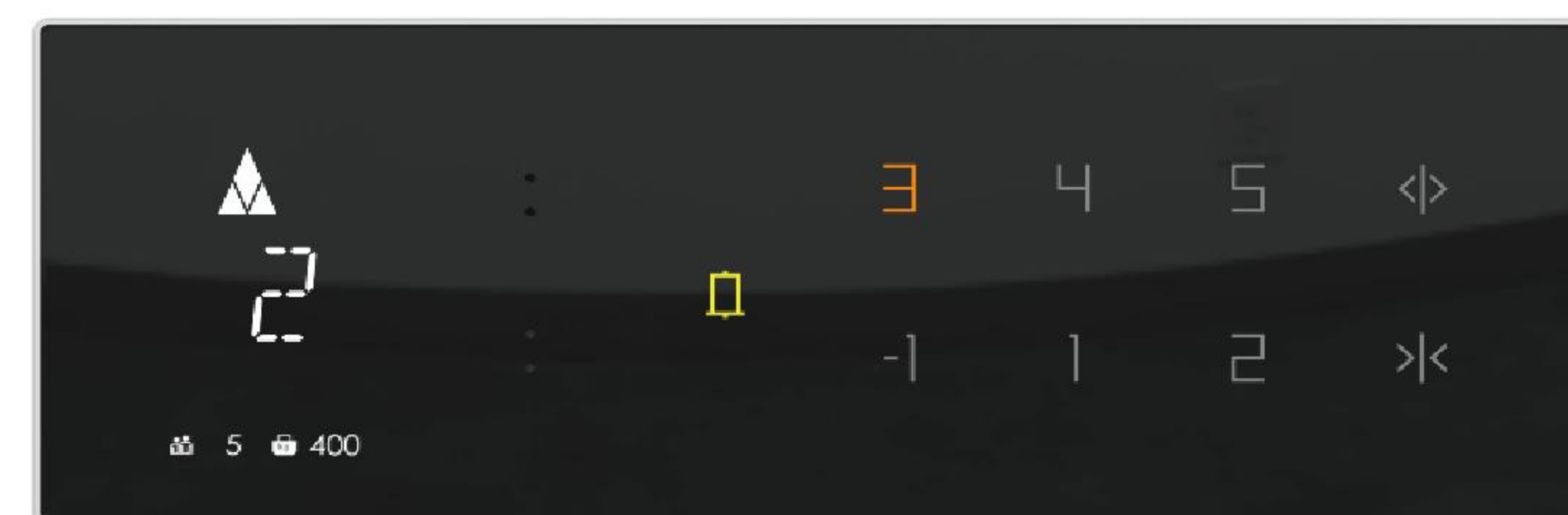

HOP028
Optional

► Operating panel



HOP026
Optional



HOP029
Standard



HOP030
Optional

► HB



HHB035
Standard



HHB036
Optional

Main Specification

Name	Escalator	Moving walk
Type	GEE	GET
Inclination	30°/35°	10°/11°/12°
Step/pallet width	600/800/1000	800/1000
No. of horizontal steps	2/3	N/A
Speed	0.5	
Power Supply	3phase AC,50HZ or 60HZ	
Transport capacity	3600/4800/6000 (Refer to step/pallet width 600,800,1000mm)	



ESCALATOR 
MOVING WALK

MOVING WALK Construction layout

GET MOVING WALK CONSTRUCTION LAYOUT

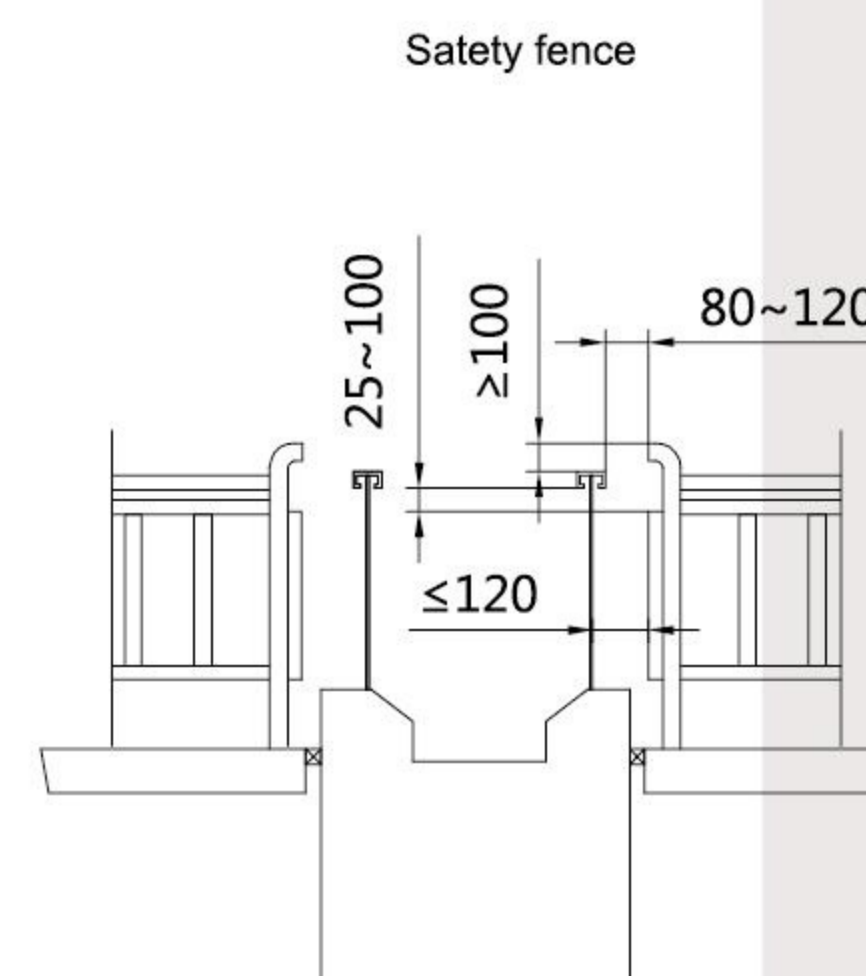
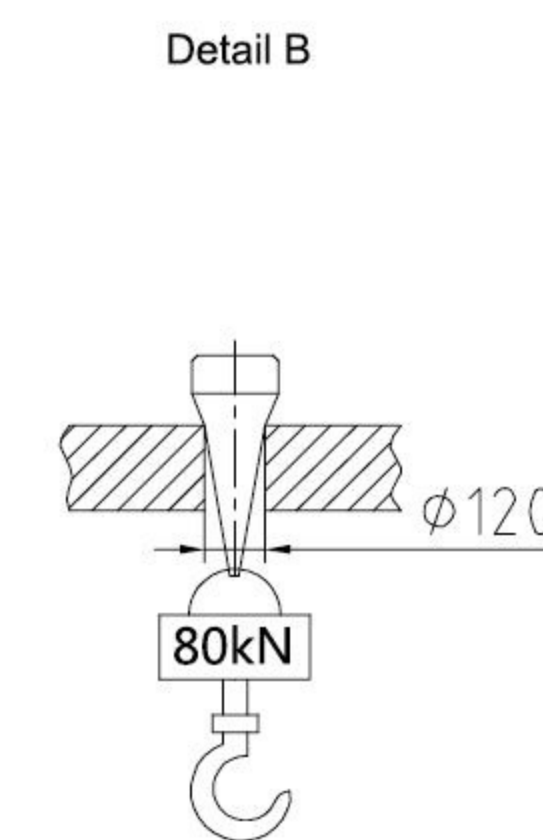
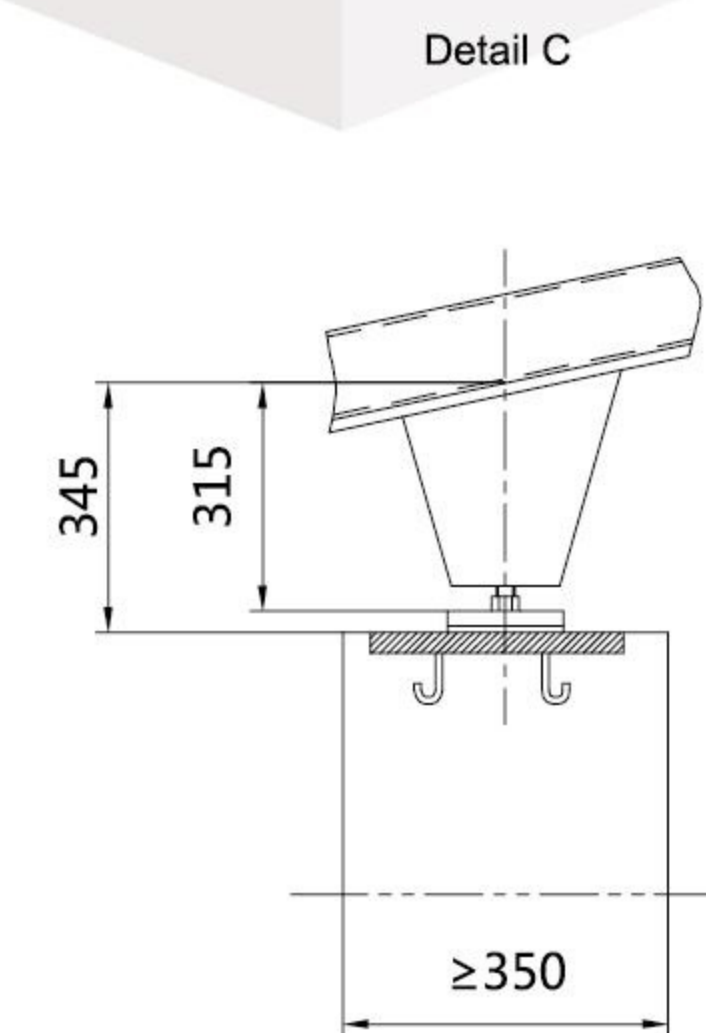
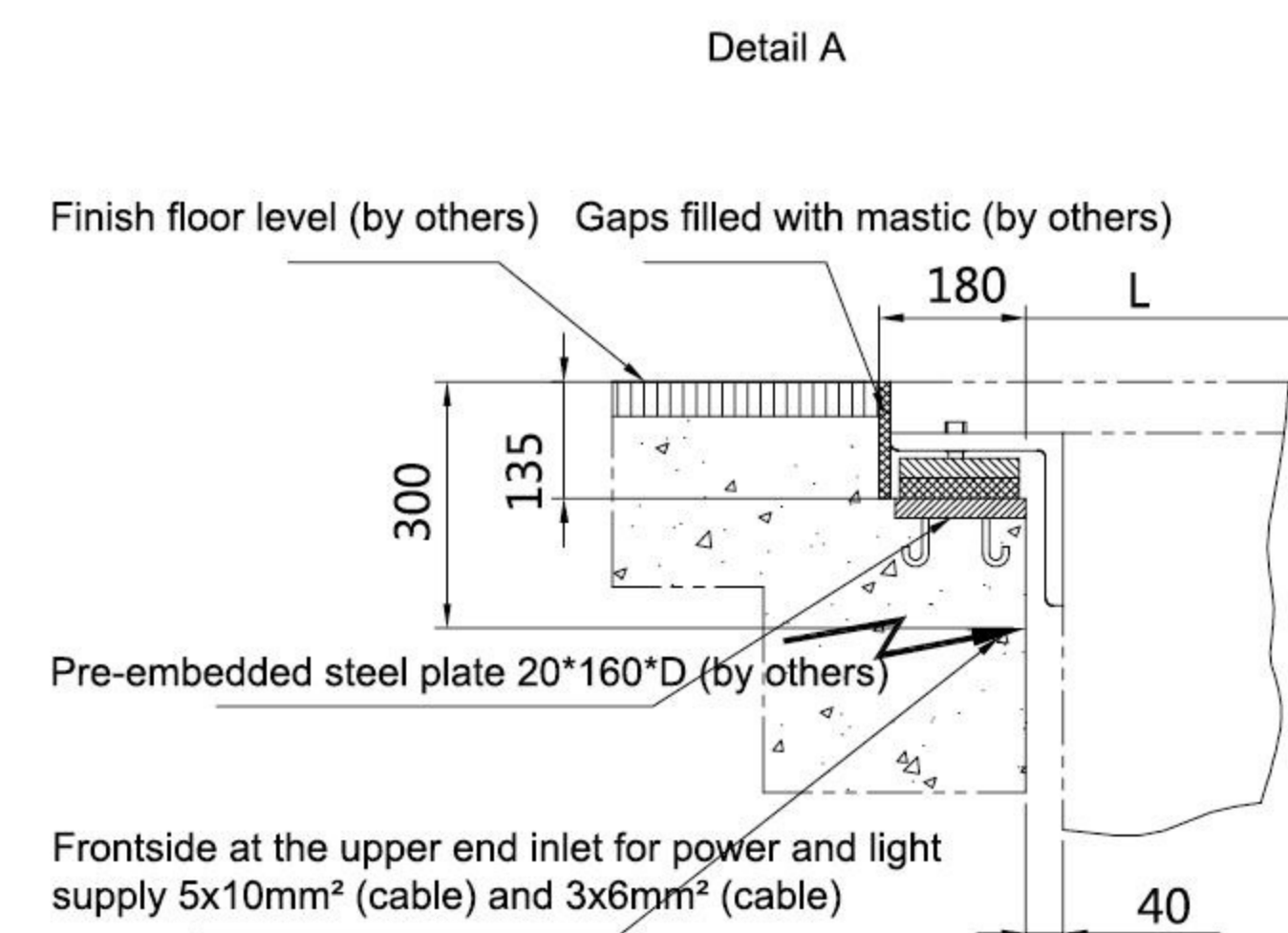
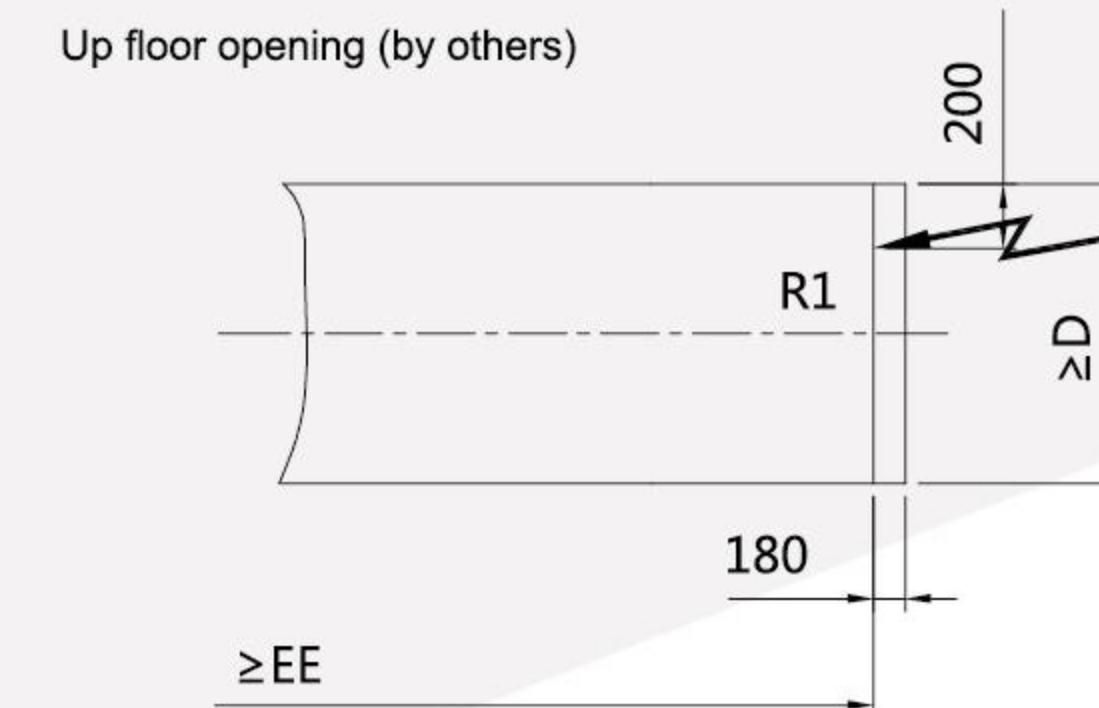
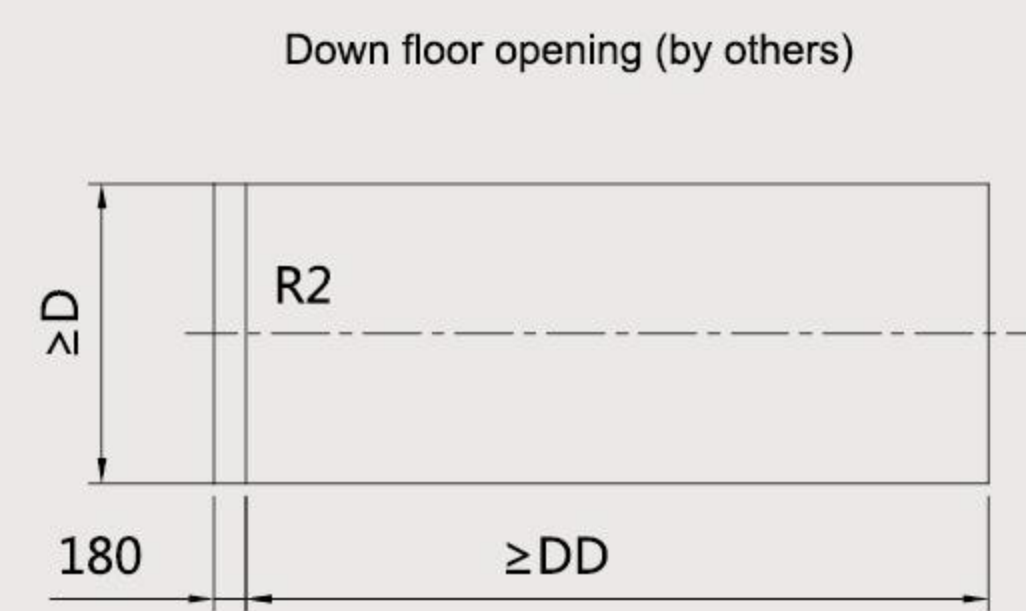
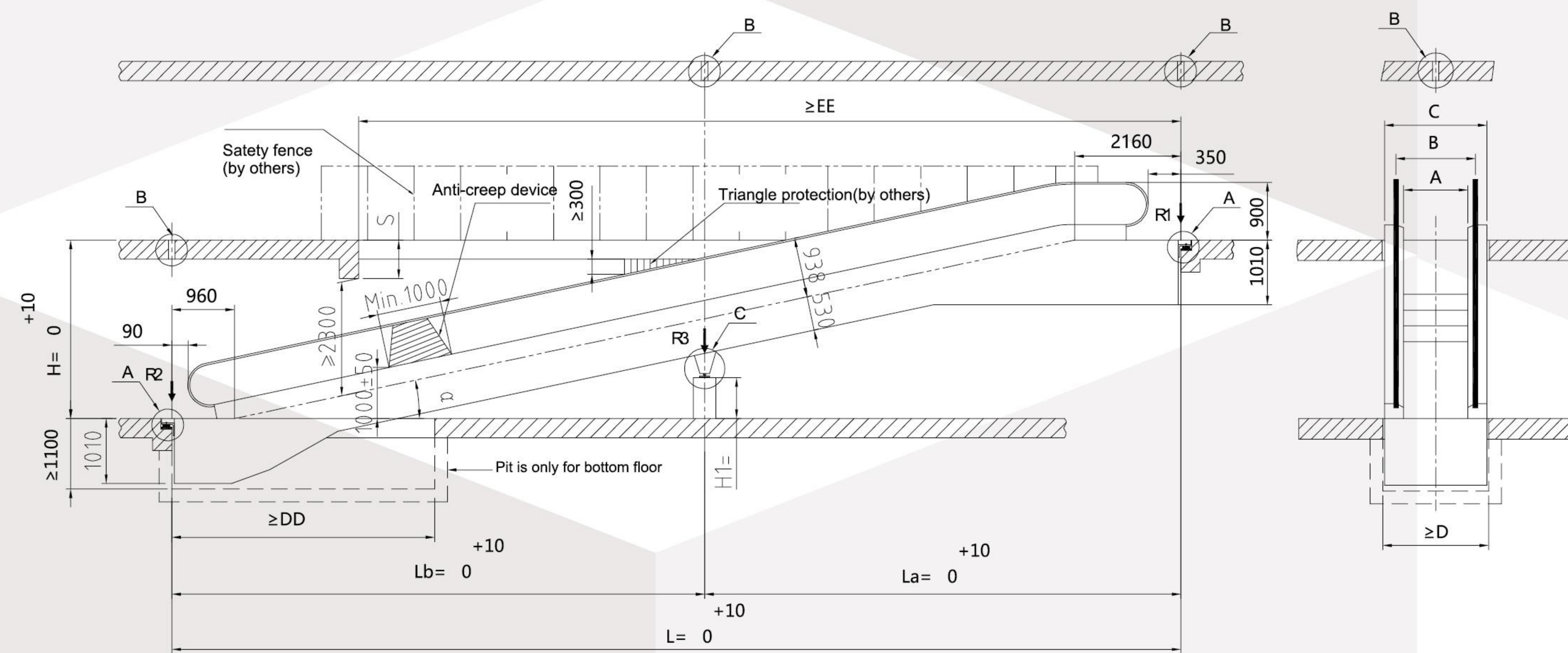

Pallet width	A	800	1000
Handrail spacer	B	1038	1238
Decoration width	C	1340	1540
Layout opening width	D	1400	1600

Pallet width	800 4800 Person/Hour	Pallet width	1000 6000 Person/Hour
H(mm) Height	(kW) Motor power	H(mm) Height	(kW) Motor power
2000~2700	5.5	2000~2500	5.5
2700~3900	7.5	2500~3700	7.5
3900~4200	8	3700~4000	8
4200~5700	11	4000~5500	11
5700~6000	13	5500~5900	13
—	—	5900~6000	15

Model	α	L	H1	DD	EE
GET	10°	5.6713 x (H+17)+ 3100	H- (La x 0.1763+ 560)	4500	15900+ 5.6713 x S
	11°	5.1446 x H+ 3100	H- (La x 0.1944+ 480)	4250	14500+ 5.1446 x S
	12°	4.7046 x (H-17)+ 3127	H- (La x 0.2126+ 460)	4000	13500+ 4.7046 x S

Add intermediate support when the distance between two support points is greater than 14.5 meters

NOTE:

- Client will be responsible for connecting power to right position into the upside of the moving walks. Main power 380V, 3-Phase, 5-Cables, 50Hz. Light power 220V, 1-Phase, 2-Cable, 50Hz, Max votage deviation allowed ±7%.
- In case of pit existing, water-proof solution must be taken into account by client. In outdoor situation, a waterspout connecting to strongdrainage system must be settled. See to that surface of the water could not be over the bottom of the truss in any cases.
- The hole for hook is located in the center of moving walks.
- During the building construction phase the unit shall be protected against dirt. Inexpert loading (e.g. by material transport) is not permitted.
- A ground device with the resistance less than 4 Ohm should be provided by client.
- The site should be reserved to the entrance channel enough.

NOTE:

- If the distance between the outside of the handrail and the wall or other obstacle is less than 400mm, a triangle guard plate must be provided as shown.
- Enough moving spaces are required near the up and down exits of the moving walks, with the width of the space not less than dimension B and the distance from the exit to the faced surrounding not less than 2500mm.
- In case of use Dual drive, upside truss extension by 420mm over the standard situation.
- Other related parameters as shown in table.
- More intermediate supports, please contact technical department.

ESCALATOR CONSTRUCTION layout

GEE ESCALATOR CONSTRUCTION LAYOUT

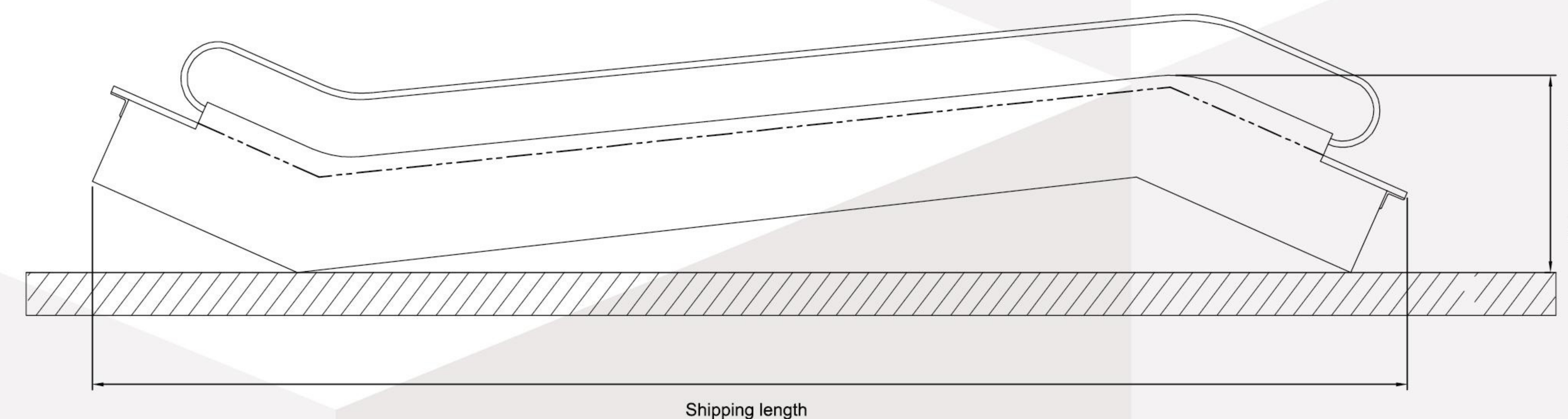
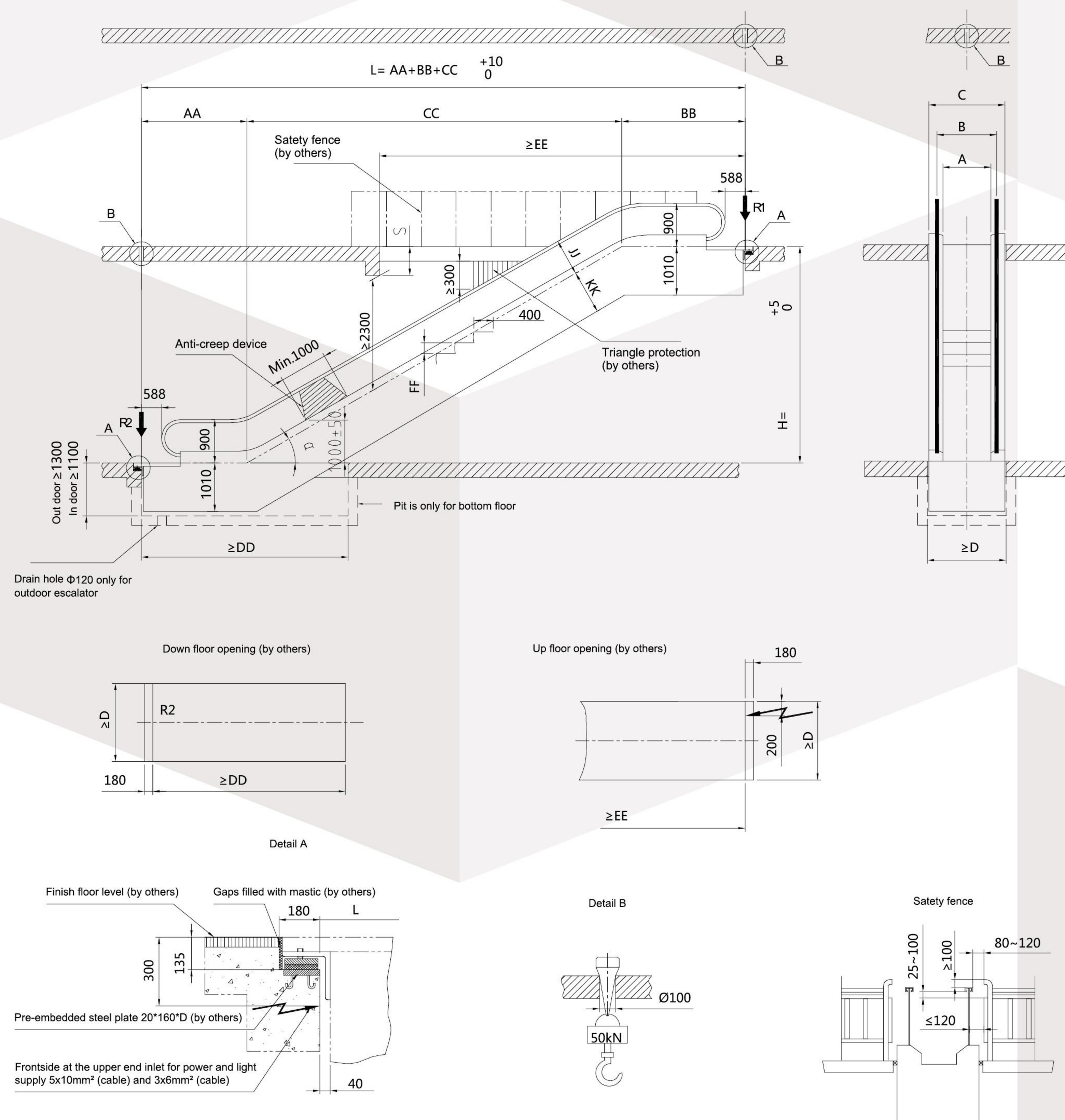

Specification Parameter of escalator

Model	Steps	a	AA	BB	CC	DD	EE	FF	JJ	KK
GEE	2	35°	2242	2663	1.428xH	4000	6150+1.428xS	230	768	917
	2	30°	2198	2567	1.732xH	4200	6750+1.732xS	200	788	897
	3	30°	2598	2967	1.732xH	4600	7150+1.732xS	200	788	897

Step width	A	600	800	1000
Handrail spacer	B	838	1038	1238
Decoration width	C	1140	1340	1540
Layout opening width	D	1200	1400	1600

Step width											
600 3600 Person/Hour				800 4800 Person/Hour				1000 6000 Person/Hour			
30°		35°		30°		35°		30°		35°	
H(mm) Height	(kW) Motor power	H(mm) Height	(kW) Motor power	H(mm) Height	(kW) Motor power	H(mm) Height	(kW) Motor power	H(mm) Height	(kW) Motor power	H(mm) Height	(kW) Motor power
2000~4000	5.5	2000~4200	5.5	2000~3500	5.5	2000~3700	5.5	2000~3300	5.5	2000~3500	5.5
4000~5400	7.5	4200~5500	7.5	3500~4900	7.5	3700~5000	7.5	3300~4700	7.5	3500~4800	7.5
5400~5700	8	5500~5700	8	4900~5200	8	5000~5200	8	4700~5000	8	4800~5000	8
5700~6500	11	5700~6000	11	5200~6100	11	5200~6000	11	5000~6000	11	5000~6000	11
6500~7800	13	—	—	6100~7300	13	—	—	6000~7200	13	—	—
7800~9100	15	—	—	7300~8600	15	—	—	7200~8500	15	—	—

NOTE:

- Client will be responsible for connecting power to right position into the upside of the escalator. Main power 380V, 3-Phase, 5-Cables, 50Hz. Light power 220V, 1-Phase, 2-Cable, 50Hz, Max voltage deviation allowed $\pm 7\%$.
- In case of pit existing, water-proof solution must be taken into account by client. In outdoor situation, a waterspout connecting to strong drainage system must be settled. See to that surface of the water could not be over the bottom of the truss in any cases.
- The hole for hook is located in the center of escalator.
- During the building construction phase the unit shall be protected against dirt. Inexpert loading (e.g. by material transport) is not permitted.
- A ground device with the resistance less than 4 Ohm should be provided by client.
- The site should be reserved to the entrance channel enough.

NOTE:

- If the distance between the outside of the handrail and the wall or other obstacle is less than 400mm, a triangle guard plate must be provided as shown.
- Enough moving spaces are required near the up and down exits of the escalator, with the width of the space not less than dimension B and the distance from the exit to the faced surrounding not less than 2500mm.
- In case of new building for step width 600mm or use Dual drive, upside truss extension by 420mm over the standard situation.
- Other related parameters as shown in table.
- If escalator height > 6000 mm or with intermediate support, please contact technical department.



► 24 hours real-time monitor solves online

GLARIE elevator carries E-service roundly, which is intelligent safe technical, and becomes the industry's first use of automobile safety standards as the content of the service enterprise. Elevator running data via mobile 3G network or Internet is sent to GLARIE professional maintenance personnel, customers or property monitoring platform. GLARIE 24 hours service center, GLARIE data monitoring server. 365 days 24 hours real-time monitoring system of GLARIE elevator provides you with all-round security.

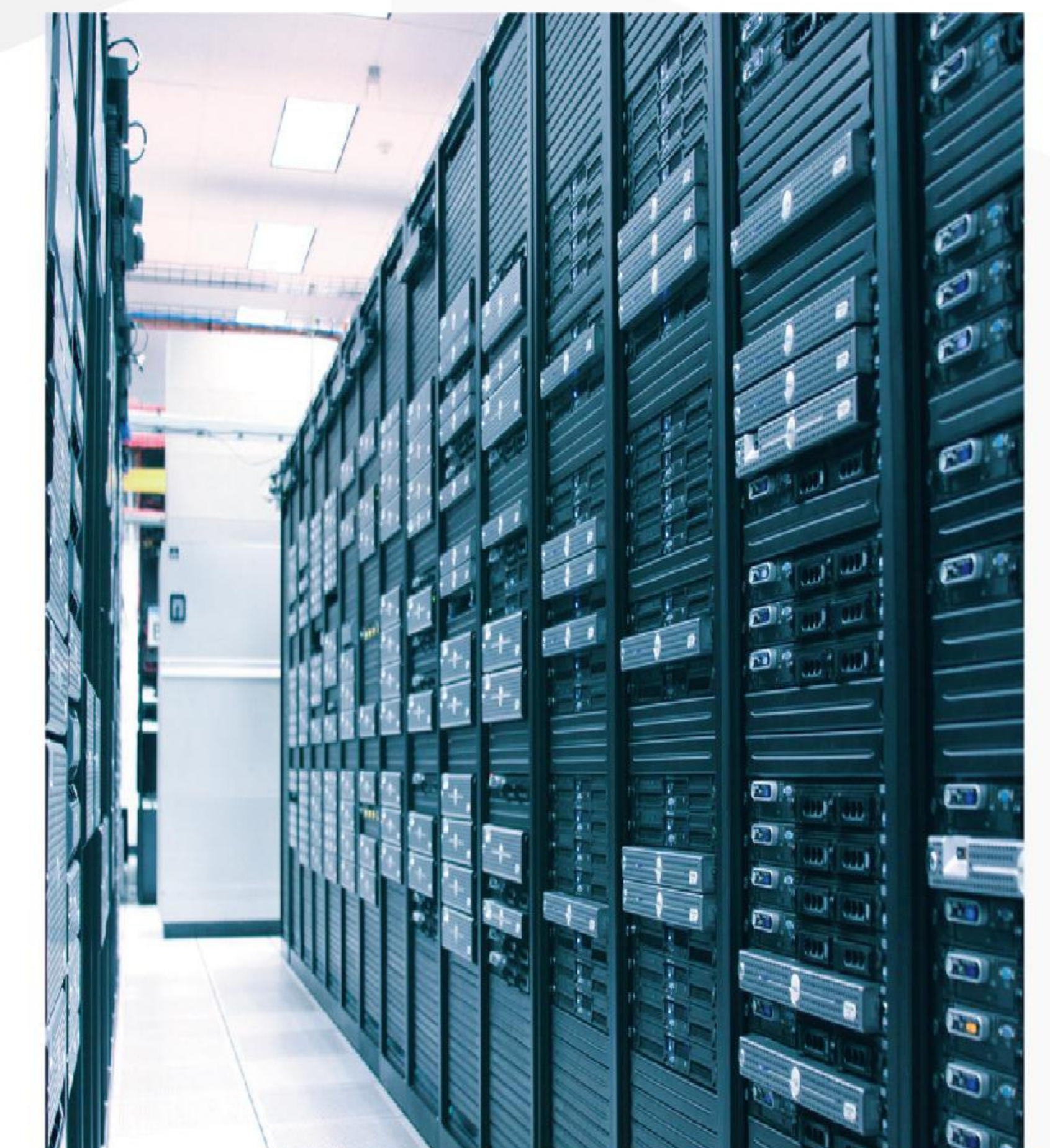

► Safe and reliable performance

Remote self-repair

When something wrong with single run data, this system can remote self-repair automatically. Ensure the normal operation of the elevator.

Monitoring running status

You will receive operation report of elevator running status from E-service every month, and to know the running status at any time.

Remind the next maintenance content

Clear list of many sets of elevator core components test results, and remind you of next maintenance parts and time timely.

GLARIE 
E-SERVICE